



UNIVERSITY OF CAMBRIDGE INTERNATIONAL EXAMINATIONS
General Certificate of Education
Advanced Subsidiary Level and Advanced Level

PHYSICS

9702/01

Paper 1 Multiple Choice

October/November 2008

1 hour

Additional Materials: Multiple Choice Answer Sheet
Soft clean eraser
Soft pencil (type B or HB is recommended)



READ THESE INSTRUCTIONS FIRST

Write in soft pencil.

Do not use staples, paper clips, highlighters, glue or correction fluid.

Write your name, Centre number and candidate number on the Answer Sheet in the spaces provided unless this has been done for you.

There are **forty** questions on this paper. Answer **all** questions. For each question there are four possible answers **A, B, C** and **D**.

Choose the **one** you consider correct and record your choice in **soft pencil** on the separate Answer Sheet.

Read the instructions on the Answer Sheet very carefully.

Each correct answer will score one mark. A mark will not be deducted for a wrong answer.

Any rough working should be done in this booklet.

This document consists of **17** printed pages and **3** blank pages.



Data

speed of light in free space,	$c = 3.00 \times 10^8 \text{ m s}^{-1}$
permeability of free space,	$\mu_0 = 4\pi \times 10^{-7} \text{ H m}^{-1}$
permittivity of free space,	$\epsilon_0 = 8.85 \times 10^{-12} \text{ F m}^{-1}$
elementary charge,	$e = 1.60 \times 10^{-19} \text{ C}$
the Planck constant,	$h = 6.63 \times 10^{-34} \text{ J s}$
unified atomic mass constant,	$u = 1.66 \times 10^{-27} \text{ kg}$
rest mass of electron,	$m_e = 9.11 \times 10^{-31} \text{ kg}$
rest mass of proton,	$m_p = 1.67 \times 10^{-27} \text{ kg}$
molar gas constant,	$R = 8.31 \text{ J K}^{-1} \text{ mol}^{-1}$
the Avogadro constant,	$N_A = 6.02 \times 10^{23} \text{ mol}^{-1}$
the Boltzmann constant,	$k = 1.38 \times 10^{-23} \text{ J K}^{-1}$
gravitational constant,	$G = 6.67 \times 10^{-11} \text{ N m}^2 \text{ kg}^{-2}$
acceleration of free fall,	$g = 9.81 \text{ m s}^{-2}$

Formulae

uniformly accelerated motion,	$s = ut + \frac{1}{2} at^2$ $v^2 = u^2 + 2as$
work done on/by a gas,	$W = p\Delta V$
gravitational potential,	$\phi = -\frac{Gm}{r}$
hydrostatic pressure,	$p = \rho gh$
pressure of an ideal gas,	$p = \frac{1}{3} \frac{Nm}{V} \langle c^2 \rangle$
simple harmonic motion,	$a = -\omega^2 x$
velocity of particle in s.h.m.,	$v = v_0 \cos \omega t$ $v = \pm \omega \sqrt{(x_0^2 - x^2)}$
electric potential,	$V = \frac{Q}{4\pi\epsilon_0 r}$
capacitors in series,	$1/C = 1/C_1 + 1/C_2 + \dots$
capacitors in parallel,	$C = C_1 + C_2 + \dots$
energy of charged capacitor,	$W = \frac{1}{2} QV$
resistors in series,	$R = R_1 + R_2 + \dots$
resistors in parallel,	$1/R = 1/R_1 + 1/R_2 + \dots$
alternating current/voltage,	$x = x_0 \sin \omega t$
radioactive decay,	$x = x_0 \exp(-\lambda t)$
decay constant,	$\lambda = \frac{0.693}{t_{\frac{1}{2}}}$

- 1 A laser emits light of wavelength 600 nm.

What is the distance, expressed as a number of wavelengths, travelled by the light in one second?

- A 5×10^8 B 5×10^{11} C 5×10^{14} D 5×10^{17}

- 2 At temperatures close to 0 K, the specific heat capacity c of a particular solid is given by $c = bT^3$, where T is the thermodynamic temperature and b is a constant characteristic of the solid.

What are the units of constant b , expressed in SI base units?

- A $\text{m}^2 \text{s}^{-2} \text{K}^{-3}$
 B $\text{m}^2 \text{s}^{-2} \text{K}^{-4}$
 C $\text{kg m}^2 \text{s}^{-2} \text{K}^{-3}$
 D $\text{kg m}^2 \text{s}^{-2} \text{K}^{-4}$

- 3 The table shows the x -component and y -component of four force vectors.

Which force vector has the largest magnitude?

	x -component / N	y -component / N
A	2	9
B	3	8
C	4	7
D	5	6

- 4 A student uses a digital ammeter to measure a current. The reading of the ammeter is found to fluctuate between 1.98 A and 2.02 A.

The manufacturer of the ammeter states that any reading has a systematic uncertainty of $\pm 1\%$.

Which value of current should be quoted by the student?

- A $(2.00 \pm 0.01) \text{ A}$
 B $(2.00 \pm 0.02) \text{ A}$
 C $(2.00 \pm 0.03) \text{ A}$
 D $(2.00 \pm 0.04) \text{ A}$

- 5 A calibration graph is produced for a faulty ammeter.

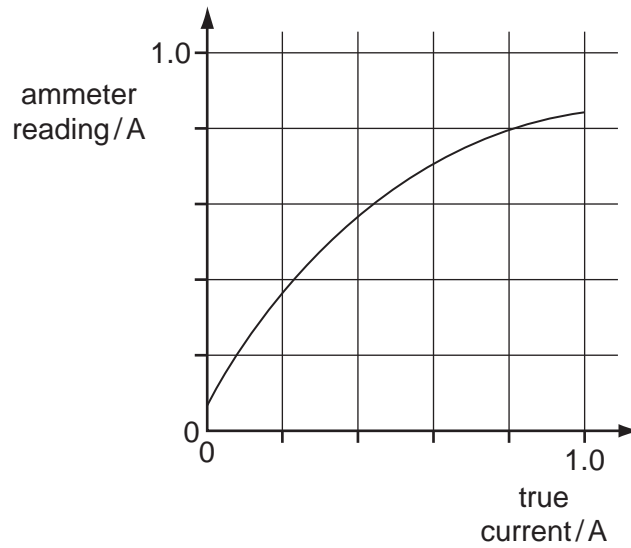

Which ammeter reading will be nearest to the correct value?

- A** 0.2A **B** 0.4A **C** 0.6A **D** 0.8A
- 6 The diagram shows a velocity-time graph for a car.

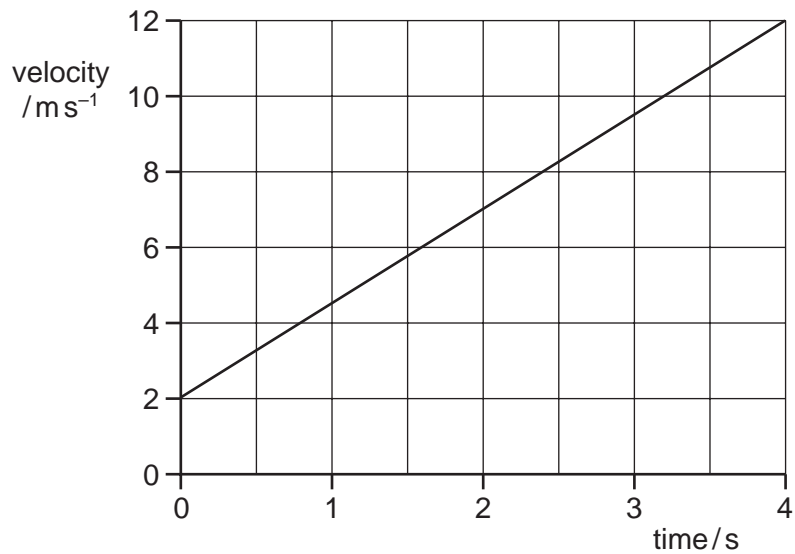

What is the distance travelled during the first 4.0 s?

- A** 2.5m **B** 3.0m **C** 20m **D** 28m

- 7 A stone is thrown upwards and follows a curved path.

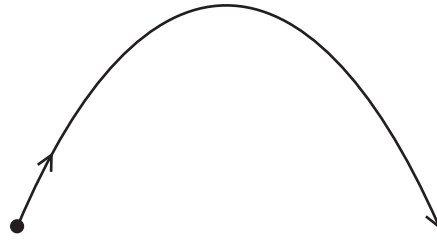

Air resistance is negligible.

Why does the path have this shape?

- A** The stone has a constant horizontal velocity and constant vertical acceleration.
B The stone has a constant horizontal acceleration and constant vertical velocity.
C The stone has a constant upward acceleration followed by a constant downward acceleration.
D The stone has a constant upward velocity followed by a constant downward velocity.
- 8 Which graph represents the motion of a car that is travelling along a straight road with a speed that increases uniformly with time?

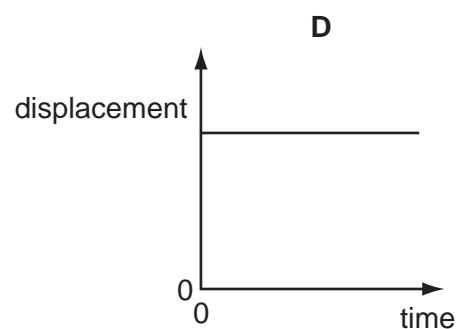
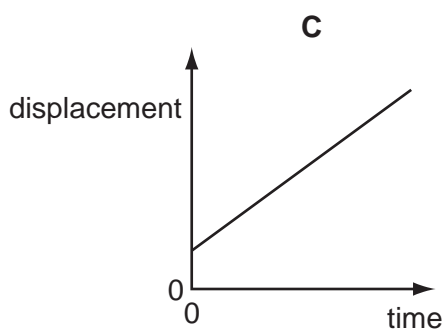
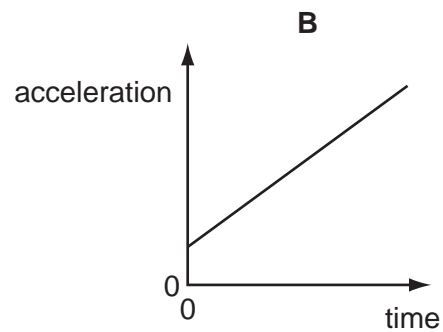
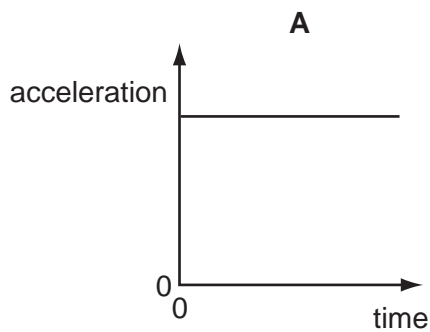

- 9 A ball falls vertically and bounces on the ground.

The following statements are about the forces acting while the ball is in contact with the ground.

Which statement is correct?

- A** The force that the ball exerts on the ground is always equal to the weight of the ball.
- B** The force that the ball exerts on the ground is always equal in magnitude and opposite in direction to the force the ground exerts on the ball.
- C** The force that the ball exerts on the ground is always less than the weight of the ball.
- D** The weight of the ball is always equal in magnitude and opposite in direction to the force that the ground exerts on the ball.
- 10 Two spheres approach each other along the same straight line. Their speeds are u_1 and u_2 before collision, and v_1 and v_2 after collision, in the directions shown below.

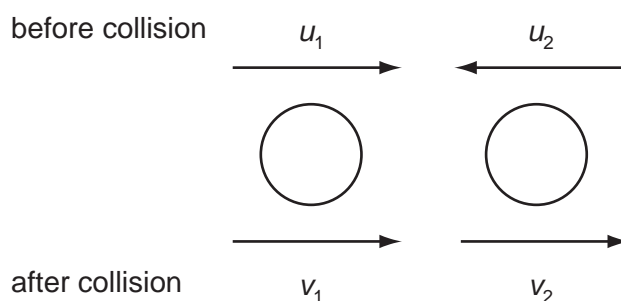

Which equation is correct if the collision is perfectly elastic?

- A** $u_1 - u_2 = v_2 + v_1$
- B** $u_1 - u_2 = v_2 - v_1$
- C** $u_1 + u_2 = v_2 + v_1$
- D** $u_1 + u_2 = v_2 - v_1$
- 11 A box of mass 8.0 kg rests on a horizontal, rough surface. A string attached to the box passes over a smooth pulley and supports a 2.0 kg mass at its other end.

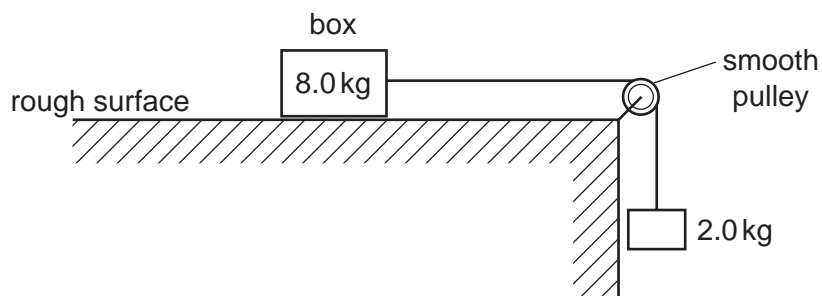

When the box is released, a friction force of 6.0 N acts on it.

What is the acceleration of the box?

- A** 1.4 ms^{-2} **B** 1.7 ms^{-2} **C** 2.0 ms^{-2} **D** 2.5 ms^{-2}

- 12 A wooden block rests on a rough board. The end of the board is then raised until the block slides down the plane of the board at constant velocity v .

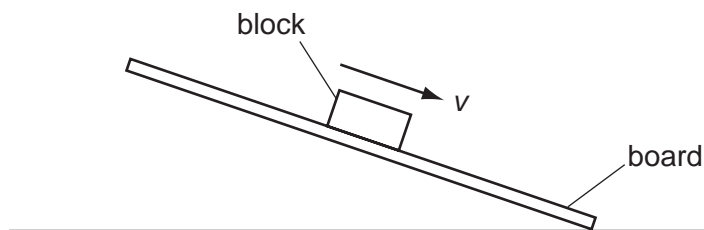

Which row describes the forces acting on the block when sliding with constant velocity?

	frictional force on block	resultant force on block
A	down the plane	down the plane
B	down the plane	zero
C	up the plane	down the plane
D	up the plane	zero

- 13 A particle is in a uniform field. The particle experiences a force in the opposite direction to the field.

Which field is the particle in, and on which property of the particle is the field acting?

	field	property of particle on which the field acts
A	electric	charge
B	electric	current
C	gravitational	mass
D	gravitational	weight

- 14 Which pair of forces acts as a couple on the circular object?

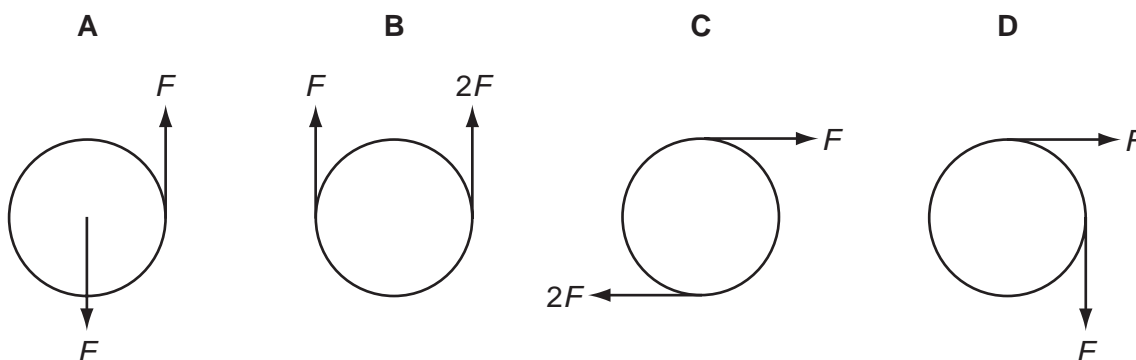

15 A block of weight W is pulled up a rough slope by a force F .

When the block has moved a distance x along the slope, it has risen height h .

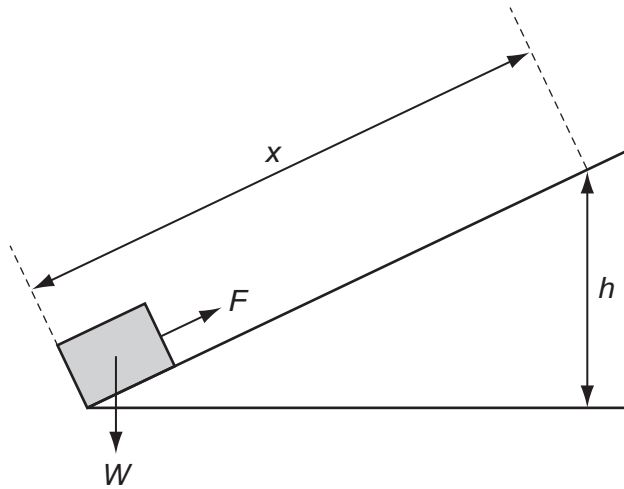

Which expressions give the amount of work done on the block and the amount of gravitational potential energy gained by the block?

	work done	gravitational potential energy
A	Fx	Wh
B	Fh	Wx
C	Wx	Fh
D	Wh	Fx

16 An object is thrown into the air.

Which graph shows how the potential energy E_p of the object varies with height h above the ground?

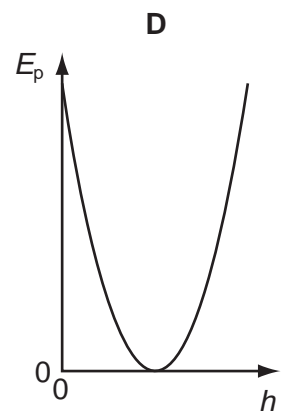
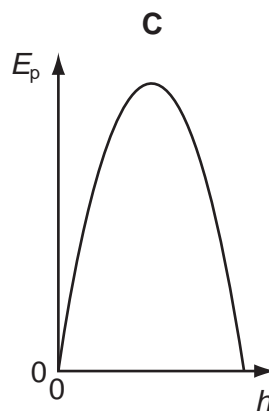
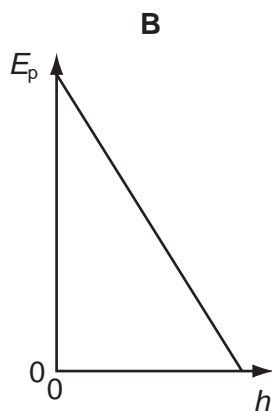
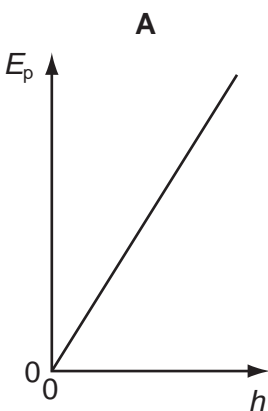

17 A pendulum bob oscillates between P and R.

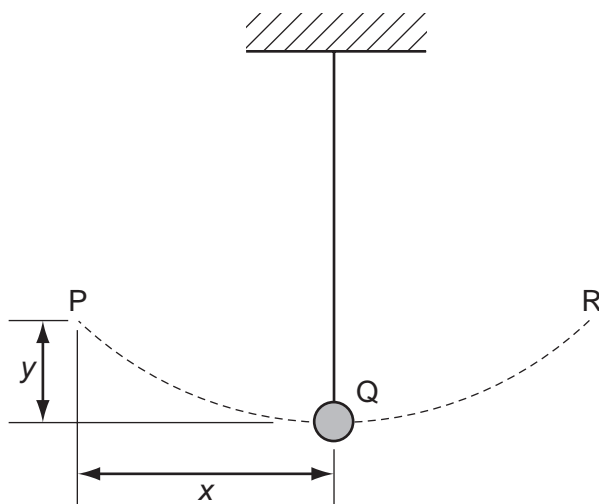

Assuming the gravitational potential energy lost in moving from P to Q is converted into kinetic energy, what is the speed of the bob at Q?

- A $\sqrt{2gx}$ B $2gx$ C $\sqrt{2gy}$ D $2gy$

18 Which operation involves the greatest mean power?

- A a car moving against a resistive force of 0.4 kN at a constant speed of 20 m s^{-1}
 B a crane lifting a weight of 3 kN at a speed of 2 m s^{-1}
 C a crane lifting a weight of 5 kN at a speed of 1 m s^{-1}
 D a weight being pulled across a horizontal surface at a speed of 6 m s^{-1} against a frictional force of 1.5 kN

19 Which properties best describe modelling clay?

- A brittle and ductile
 B ductile and elastic
 C elastic and plastic
 D plastic and ductile

20 Why does the pressure of a gas increase when the gas is compressed at constant temperature?

- A The gas molecules collide more often with each other.
 B The gas molecules expand under pressure.
 C The gas molecules hit the walls of the container more frequently.
 D The gas molecules travel faster.

- 21 A number of similar springs, each having the same spring constant, are joined in four arrangements. The same load is applied to each.

Which arrangement gives the greatest extension?

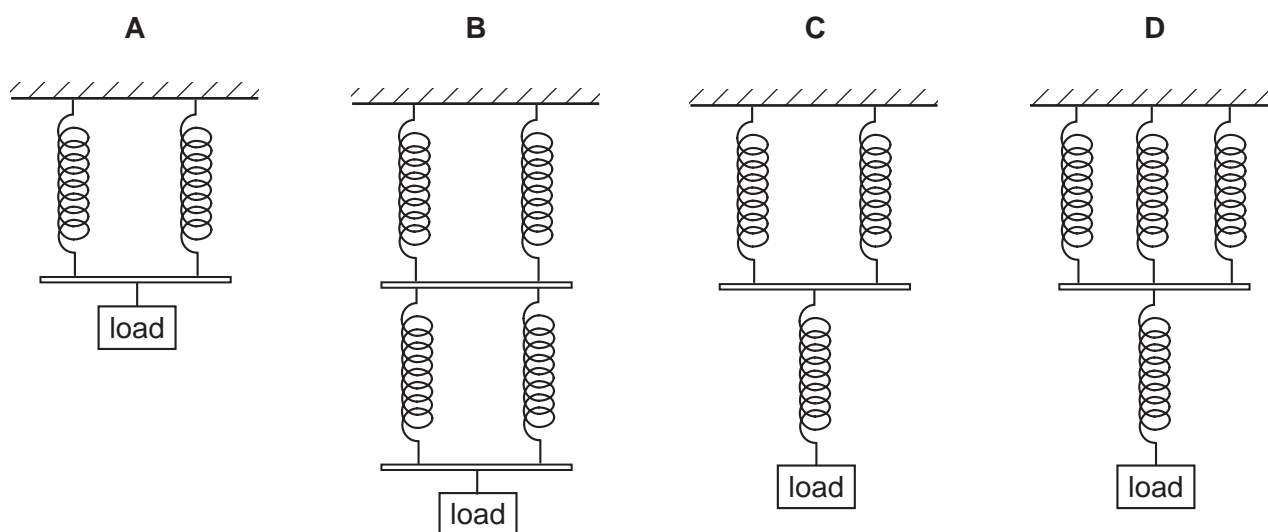

- 22 The graphs show how force varies with extension and stress varies with strain for the loading of a metal wire.

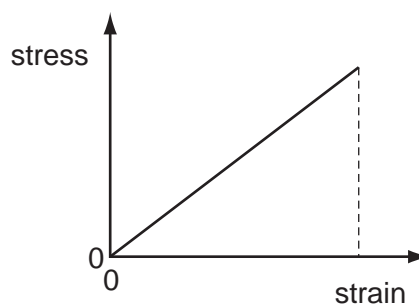
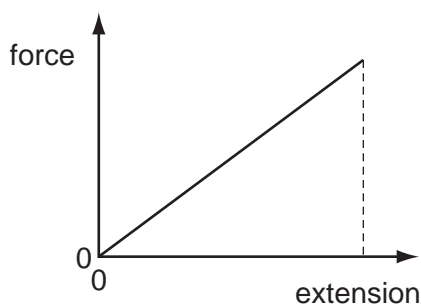

The Young modulus for this wire is equal to

- A the gradient of the force-extension graph.
 - B the area between the force-extension graph and the extension axis.
 - C the gradient of the stress-strain graph.
 - D the area between the stress-strain graph and the strain axis.
- 23 For a wire, Hooke's law is obeyed for a tension F and extension x . The Young modulus for the material of the wire is E .

Which expression represents the elastic strain energy stored in the wire?

- A $\frac{1}{2} Ex$
- B Ex
- C $\frac{1}{2} Fx$
- D Fx

24 The diagram shows two waves X and Y.

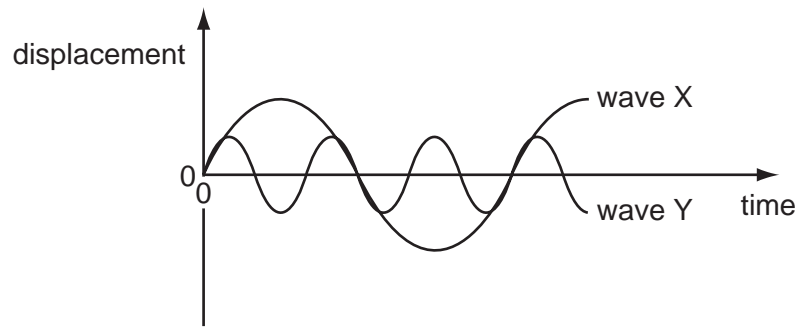

Wave X has amplitude 8 cm and frequency 100 Hz.

What are the amplitude and frequency of wave Y?

	amplitude / cm	frequency / Hz
A	2	33
B	2	300
C	4	33
D	4	300

25 Light can exhibit all of the properties listed.

Which property can sound **not** exhibit?

- A** interference
- B** polarisation
- C** refraction
- D** total internal reflection

- 26 The diagram represents the screen of a cathode-ray oscilloscope displaying two sound waves labelled X and Y.

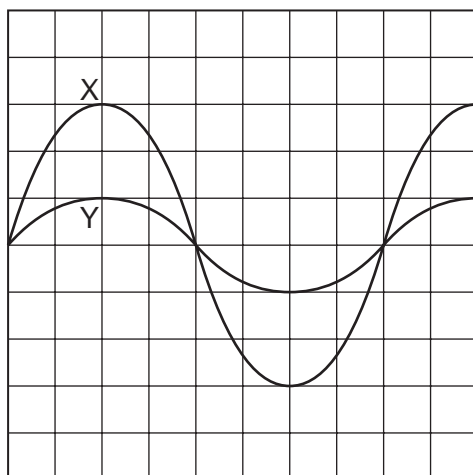

What is the ratio $\frac{\text{intensity of sound wave X}}{\text{intensity of sound wave Y}}$?

- A $\frac{9}{1}$ B $\frac{3}{1}$ C $\frac{\sqrt{3}}{1}$ D $\frac{1}{1}$
- 27 T is a microwave transmitter placed at a fixed distance from a flat reflecting surface S.

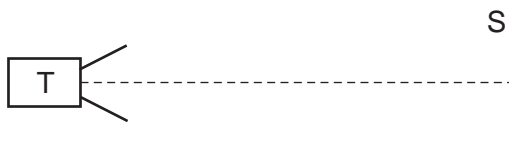

A small microwave receiver is moved from T towards S and receives signals of alternate maxima and minima of intensity.

The distance between one maximum and the next is 15 mm.

What is the frequency of the microwaves?

- A 1.0×10^7 Hz
 B 2.0×10^7 Hz
 C 1.0×10^{10} Hz
 D 2.0×10^{10} Hz

28 The diagram shows two loudspeakers producing sound waves that are in phase.

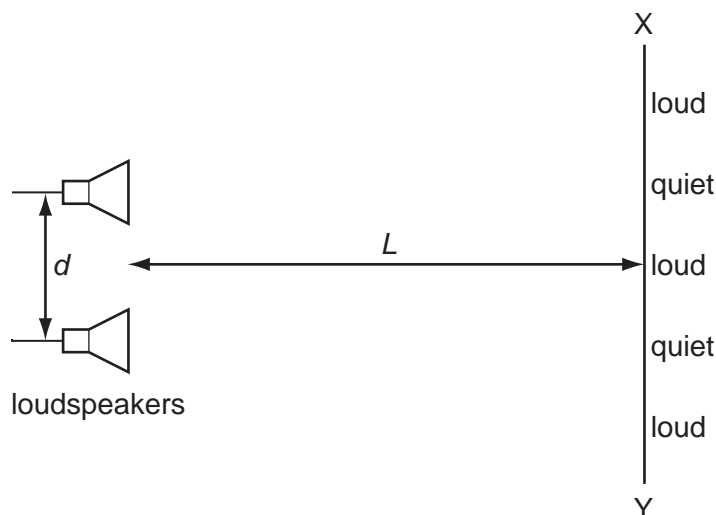

As a student moves from X to Y, the intensity of the note she hears is alternately loud and quiet.

The distance between adjacent loud and quiet regions may be reduced by

- A decreasing distance d .
- B increasing distance L .
- C decreasing the amplitude.
- D increasing the frequency.

29 The diagram shows the electric field near a point charge and two electrons X and Y.

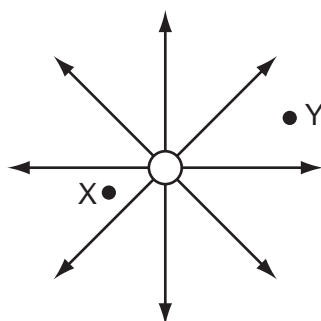

Which row describes the forces acting on X and Y?

	direction of force	magnitude of force on X
A	radially inwards	less than force on Y
B	radially inwards	greater than force on Y
C	radially outwards	less than force on Y
D	radially outwards	greater than force on Y

- 30 A particle has a charge of 4.8×10^{-19} C. The particle remains at rest between a pair of horizontal, parallel plates having a separation of 15 mm. The potential difference between the plates is 660 V.

What is the weight of the particle?

- A 2.1×10^{-14} N
 B 2.1×10^{-15} N
 C 2.1×10^{-17} N
 D 1.1×10^{-23} N

- 31 Two wires P and Q made of the same material and of the same length are connected in parallel to the same voltage supply. Wire P has diameter 2 mm and wire Q has diameter 1 mm.

What is the ratio $\frac{\text{current in P}}{\text{current in Q}}$?

- A $\frac{1}{4}$ B $\frac{1}{2}$ C $\frac{2}{1}$ D $\frac{4}{1}$

- 32 An electric power cable consists of six copper wires c surrounding a steel core s.

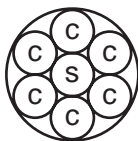

1.0 km of one of the copper wires has a resistance of 10Ω and 1.0 km of the steel core has a resistance of 100Ω .

What is the approximate resistance of a 1.0 km length of the power cable?

- A 0.61Ω B 1.6Ω C 160Ω D 610Ω

- 33 Which graph best represents the way the current I through a filament lamp varies with the potential difference V across it?

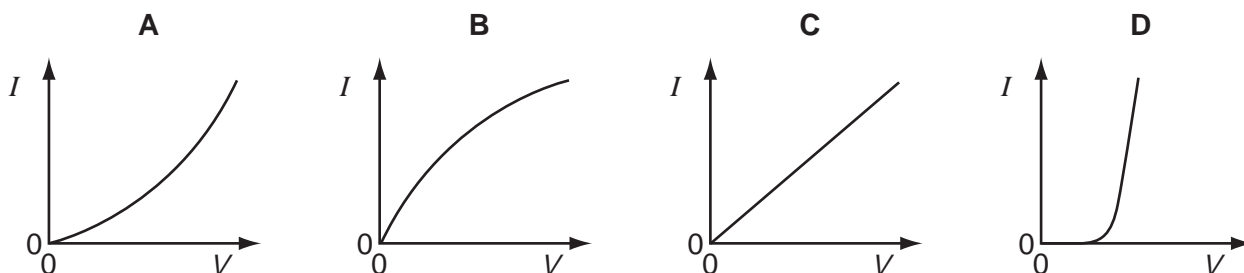

- 34 The charge that a fully-charged 12V car battery can supply is 100kC. The starter motor of the car requires a current of 200A for an average period of 2.0s. The battery does not recharge because of a fault.

What is the maximum number of times the starter motor of the car can be used?

- A 21 B 25 C 42 D 250

- 35 The diagram shows a circuit containing three resistors in parallel.

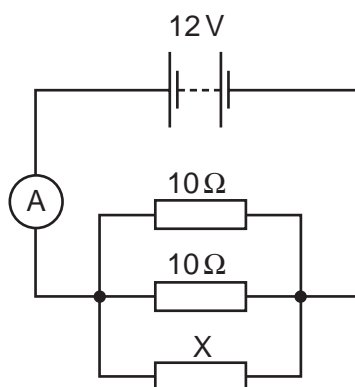

The battery has e.m.f. 12V and negligible internal resistance. The ammeter reading is 3.2A.

What is the resistance of X?

- A 2.1Ω B 4.6Ω C 6.0Ω D 15Ω

- 36 The e.m.f. of the battery is 9.0V. The reading on the high-resistance voltmeter is 7.5V.

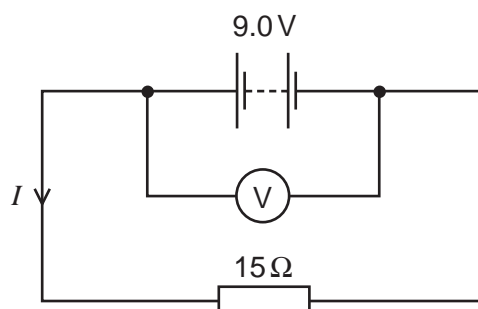

What is the current I ?

- A 0.10A B 0.50A C 0.60A D 2.0A

37 The diagram shows a potentiometer circuit.

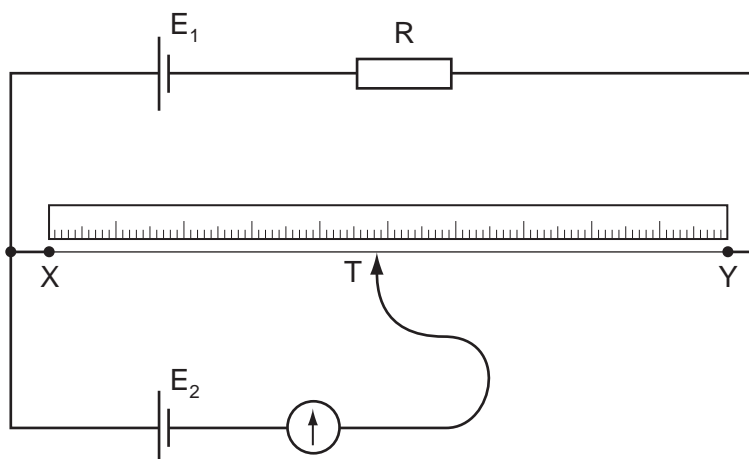

The contact T is placed on the wire and moved along the wire until the galvanometer reading is zero. The length XT is then noted.

In order to calculate the potential difference per unit length on the wire XY, which value must also be known?

- A the e.m.f. of the cell E_1
- B the e.m.f. of the cell E_2
- C the resistance of resistor R
- D the resistance of the wire XY

38 Which conclusion can be drawn from the results of the experiment showing the scattering of α -particles by gold foil?

- A Electrons orbit the atomic nucleus in well-defined paths.
- B Nuclei of different isotopes contain different numbers of neutrons.
- C The atomic nucleus contains protons and neutrons.
- D The nucleus is very small compared with the size of the atom.

39 A nucleus Q has the notation ${}^y_x\text{Q}$.

Which of the following is an isotope of Q?

- A ${}^{y-1}_x\text{Q}$
- B ${}^y_{x-1}\text{Q}$
- C ${}^y_{x+1}\text{Q}$
- D ${}^{y-1}_{x+1}\text{Q}$

40 A ${}^{238}_{92}\text{U}$ nucleus decays in two stages to a ${}^{234}_{91}\text{Pa}$ nucleus.

What was emitted in these two stages?

- A $\alpha + \beta$
- B $\alpha + \gamma$
- C $\beta + \beta$
- D $\beta + \gamma$

BLANK PAGE

BLANK PAGE

BLANK PAGE

Permission to reproduce items where third-party owned material protected by copyright is included has been sought and cleared where possible. Every reasonable effort has been made by the publisher (UCLES) to trace copyright holders, but if any items requiring clearance have unwittingly been included, the publisher will be pleased to make amends at the earliest possible opportunity.

University of Cambridge International Examinations is part of the Cambridge Assessment Group. Cambridge Assessment is the brand name of University of Cambridge Local Examinations Syndicate (UCLES), which is itself a department of the University of Cambridge.