

UNIVERSITY OF CAMBRIDGE INTERNATIONAL EXAMINATIONS
General Certificate of Education
Advanced Subsidiary Level and Advanced Level

PHYSICS

9702/01

Paper 1 Multiple Choice

October/November 2004

1 hour

Additional Materials: Multiple Choice Answer Sheet
Soft clean eraser
Soft pencil (type B or HB is recommended)

READ THESE INSTRUCTIONS FIRST

Write in soft pencil.

Do not use staples, paper clips, highlighters, glue or correction fluid.

Write your name, Centre number and candidate number on the Answer Sheet in the spaces provided unless this has been done for you.

There are **forty** questions on this paper. Answer **all** questions.

For each question there are four possible answers **A, B, C** and **D**. Choose the **one** you consider correct and record your choice in **soft pencil** on the separate Answer Sheet.

Read the instructions on the Answer Sheet very carefully.

Each correct answer will score one mark. A mark will not be deducted for a wrong answer.

Any rough working should be done in this booklet.

This document consists of **17** printed pages and **3** blank pages.



Data

speed of light in free space,	$c = 3.00 \times 10^8 \text{ m s}^{-1}$
permeability of free space,	$\mu_0 = 4\pi \times 10^{-7} \text{ H m}^{-1}$
permittivity of free space,	$\epsilon_0 = 8.85 \times 10^{-12} \text{ F m}^{-1}$
elementary charge,	$e = 1.60 \times 10^{-19} \text{ C}$
the Planck constant,	$h = 6.63 \times 10^{-34} \text{ J s}$
unified atomic mass constant,	$u = 1.66 \times 10^{-27} \text{ kg}$
rest mass of electron,	$m_e = 9.11 \times 10^{-31} \text{ kg}$
rest mass of proton,	$m_p = 1.67 \times 10^{-27} \text{ kg}$
molar gas constant,	$R = 8.31 \text{ J K}^{-1} \text{ mol}^{-1}$
the Avogadro constant,	$N_A = 6.02 \times 10^{23} \text{ mol}^{-1}$
the Boltzmann constant,	$k = 1.38 \times 10^{-23} \text{ J K}^{-1}$
gravitational constant,	$G = 6.67 \times 10^{-11} \text{ N m}^2 \text{ kg}^{-2}$
acceleration of free fall,	$g = 9.81 \text{ m s}^{-2}$

Formulae

uniformly accelerated motion,

$$s = ut + \frac{1}{2}at^2$$

$$v^2 = u^2 + 2as$$

work done on/by a gas,

$$W = p\Delta V$$

gravitational potential,

$$\phi = -\frac{Gm}{r}$$

simple harmonic motion,

$$a = -\omega^2 x$$

velocity of particle in s.h.m.,

$$v = v_0 \cos \omega t$$

$$v = \pm \omega \sqrt{(x_0^2 - x^2)}$$

resistors in series,

$$R = R_1 + R_2 + \dots$$

resistors in parallel,

$$1/R = 1/R_1 + 1/R_2 + \dots$$

electric potential,

$$V = \frac{Q}{4\pi\epsilon_0 r}$$

capacitors in series,

$$1/C = 1/C_1 + 1/C_2 + \dots$$

capacitors in parallel,

$$C = C_1 + C_2 + \dots$$

energy of charged capacitor,

$$W = \frac{1}{2}QV$$

alternating current/voltage,

$$x = x_0 \sin \omega t$$

hydrostatic pressure,

$$p = \rho gh$$

pressure of an ideal gas,

$$p = \frac{1}{3} \frac{Nm}{V} \langle c^2 \rangle$$

radioactive decay,

$$x = x_0 \exp(-\lambda t)$$

decay constant,

$$\lambda = \frac{0.693}{t_{\frac{1}{2}}}$$

critical density matter of the Universe,

$$\rho_0 = \frac{3H_0^2}{8\pi G}$$

equation of continuity,

$$Av = \text{constant}$$

Bernoulli equation (simplified),

$$p_1 + \frac{1}{2}\rho v_1^2 = p_2 + \frac{1}{2}\rho v_2^2$$

Stokes' law,

$$F = Ar\eta v$$

Reynolds' number,

$$R_e = \frac{\rho v r}{\eta}$$

drag force in turbulent flow,

$$F = Br^2 \rho v^2$$

- 1 Which line of the table gives values that are equal to a time of 1 ps (one picosecond) and a distance of 1 Gm (one gigametre)?

	time of 1 ps	distance of 1 Gm
A	10^{-9} s	10^9 m
B	10^{-9} s	10^{12} m
C	10^{-12} s	10^9 m
D	10^{-12} s	10^{12} m

- 2 Which of the following definitions is correct and uses only quantities rather than units?

- A** Density is mass per cubic metre.
- B** Potential difference is energy per unit current.
- C** Pressure is force per unit area.
- D** Speed is distance travelled per second.

- 3 When a beam of light is incident on a surface, it delivers energy to the surface. The intensity of the beam is defined as the energy delivered per unit area per unit time.

What is the unit of intensity, expressed in SI base units?

- A** $\text{kg m}^{-2} \text{ s}^{-1}$ **B** $\text{kg m}^2 \text{ s}^{-3}$ **C** kg s^{-2} **D** kg s^{-3}

- 4 The deflection of the needle of an ammeter varies with the current passing through the ammeter as shown in the graph.

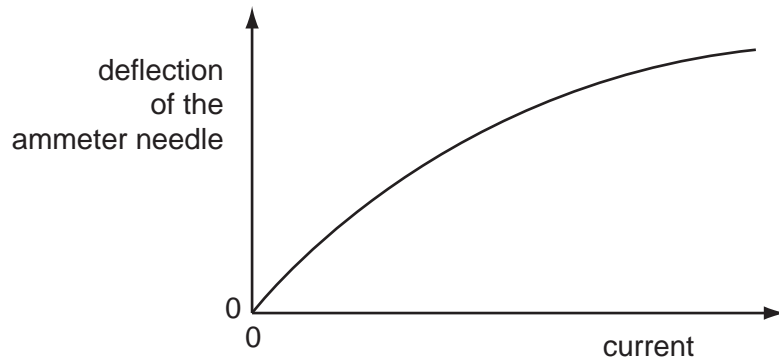

Which diagram could represent the appearance of the scale of this meter?

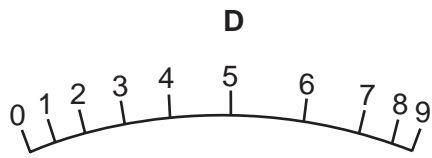
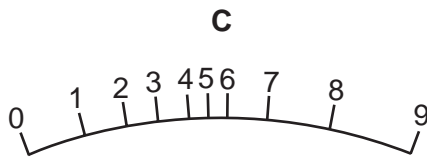
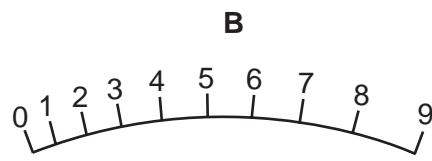
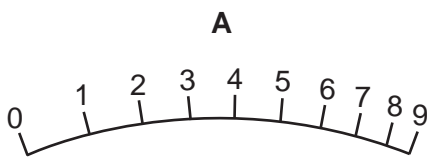

- 5 When a 12 V 50 Hz supply is connected to the Y-terminals of an oscilloscope, the trace in the diagram is obtained.

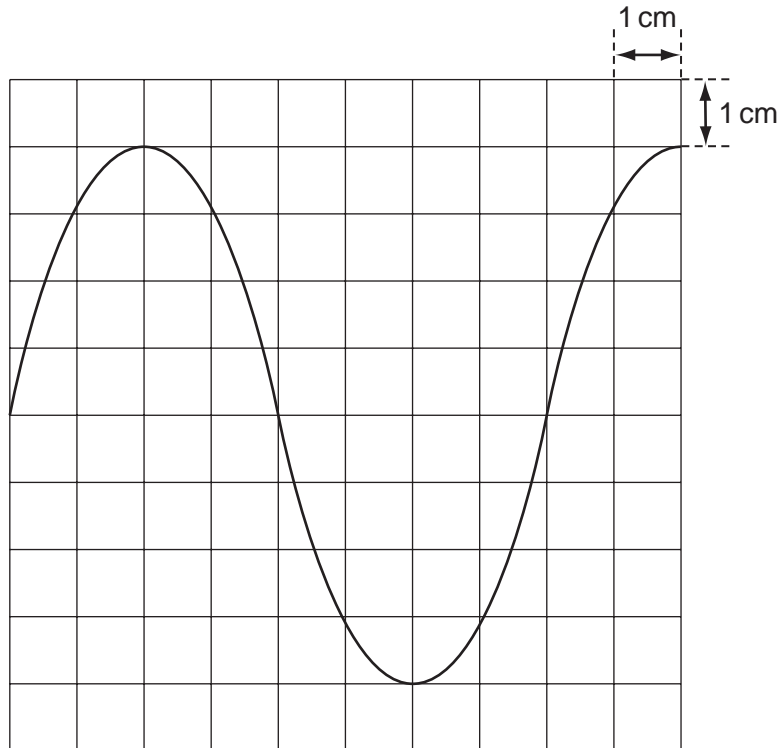

What is the setting of the time-base control?

- A** 2.0 ms cm^{-1} **B** 2.5 ms cm^{-1} **C** 5 ms cm^{-1} **D** 20 ms cm^{-1}
- 6 Four students each made a series of measurements of the acceleration of free fall g . The table shows the results obtained.

Which student obtained a set of results that could be described as precise but not accurate?

student	results, $g / \text{m s}^{-2}$			
A	9.81	9.79	9.84	9.83
B	9.81	10.12	9.89	8.94
C	9.45	9.21	8.99	8.76
D	8.45	8.46	8.50	8.41

- 7 In the absence of air resistance, a stone is thrown from **P** and follows a parabolic path in which the highest point reached is **T**. The stone reaches point **Q** just before landing.

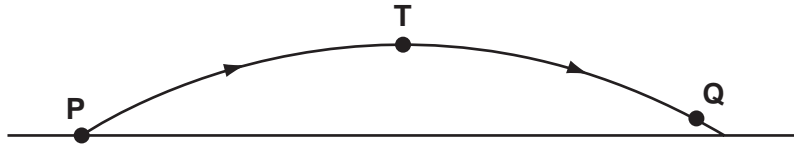

The vertical component of acceleration of the stone is

- A** zero at **T**.
B greatest at **T**.
C greatest at **Q**.
D the same at **Q** as at **T**.
- 8 When a car driver sees a hazard ahead, she applies the brakes as soon as she can and brings the car to rest. The graph shows how the speed v of the car varies with time t after the hazard is seen.

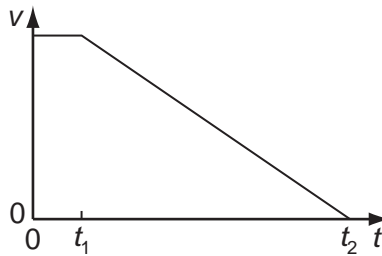

Which graph represents the variation with time t of the distance s travelled by the car after the hazard has been seen?

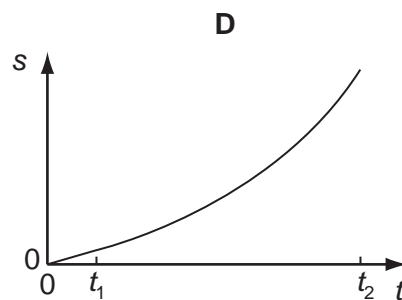
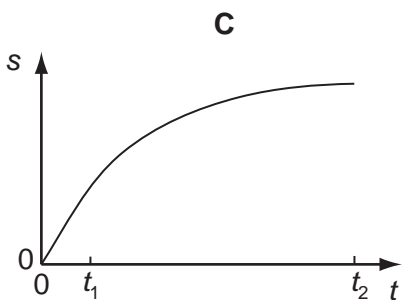
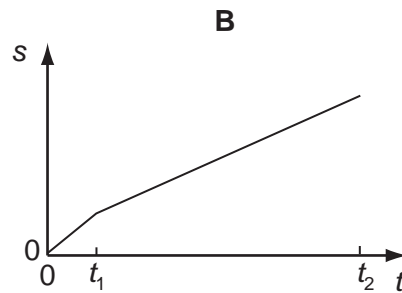
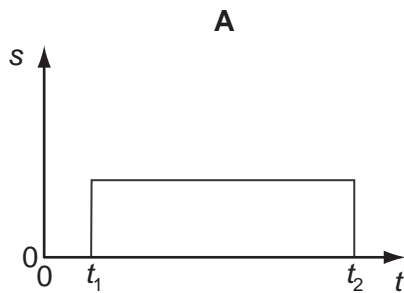

- 9 An object falls 10.0 m from rest before entering some water.

Assuming negligible air resistance, what is the time taken to reach the water and the speed with which the object reaches the water?

	time / ms	speed / m s^{-1}
A	1.02	10.0
B	1.02	14.0
C	1.43	10.0
D	1.43	14.0

- 10 A constant mass undergoes uniform acceleration.

Which of the following is a correct statement about the resultant force acting on the mass?

- A** It increases uniformly with respect to time.
B It is constant but not zero.
C It is proportional to the displacement from a fixed point.
D It is proportional to the velocity.
- 11 A particle of mass m strikes a vertical rigid wall perpendicularly from the left with velocity v .

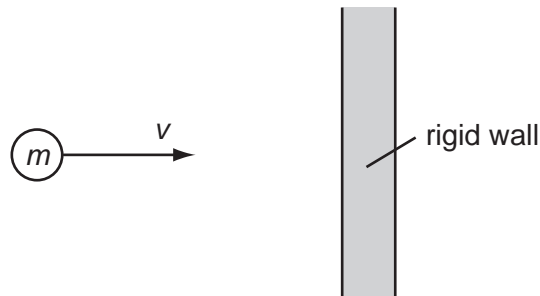

If the collision is perfectly elastic, the total change in momentum of the particle that occurs as a result of the collision is

- A** $2mv$ to the right.
B $2mv$ to the left.
C mv to the right.
D mv to the left.

12 Which two vector diagrams represent forces in equilibrium?

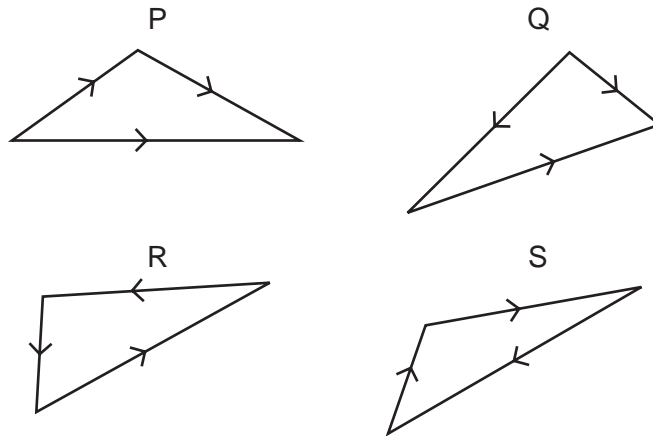

- A P and Q
- B Q and R
- C R and S
- D S and P

13 A long uniform beam is pivoted at one end. A force of 300 N is applied to hold the beam horizontally.

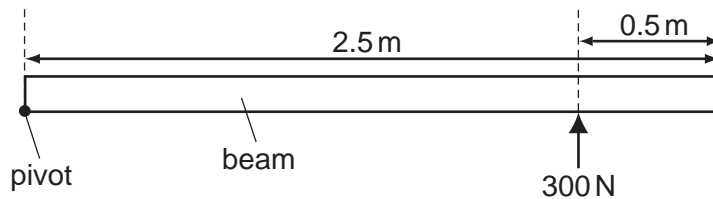

What is the weight of the beam?

- A 300 N
- B 480 N
- C 600 N
- D 960 N

14 An electron is situated in a uniform electric field, as shown in the diagram.

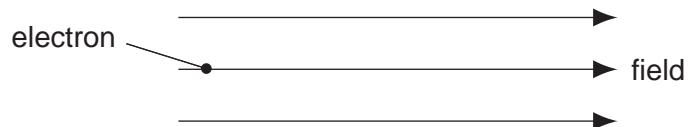

What is the direction of the electric force acting on the electron?

- A downwards
- B to the left
- C to the right
- D upwards

- 15 The kinetic energy of a particle is increased by a factor of 4.

By what factor does its speed increase?

- A 2 B 4 C 8 D 16

- 16 A horizontal force of 90 N is used to push a box across a horizontal floor. The frictional force on the box is 50 N.

What is the gain in kinetic energy of the box when it is moved through a distance of 6.0 m?

- A 240 J B 300 J C 540 J D 840 J

- 17 A cyclist is capable of generating an average power of 3.0 kW during a 4.0 km speed trial. His aerodynamic suit and position on the cycle reduce resistive forces to 180 N.

What is the approximate time achieved in the speed trial?

- A 140 s B 240 s C 1300 s D 2200 s

- 18 A constant force of 9.0 kN, parallel to an inclined plane, moves a body of weight 20 kN through a distance of 40 m along the plane at constant speed. The body gains 12 m in height, as shown.

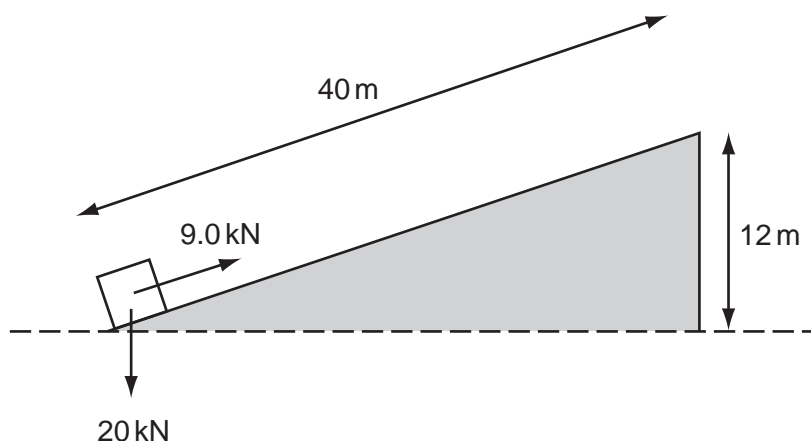

How much of the work done is dissipated as heat?

- A 120 kJ B 240 kJ C 360 kJ D 600 kJ

- 19 Which statement applies to the boiling but **not** to the evaporation of a liquid?

- A All the bonds between molecules in the liquid are broken.
 B At normal atmospheric pressure, the process occurs at one temperature only.
 C Energy must be provided for the process to happen.
 D The separation of the molecules increases greatly.

- 20 The diagram shows two liquids, labelled P and Q, which do **not** mix. The liquids are in equilibrium in an open U-tube.

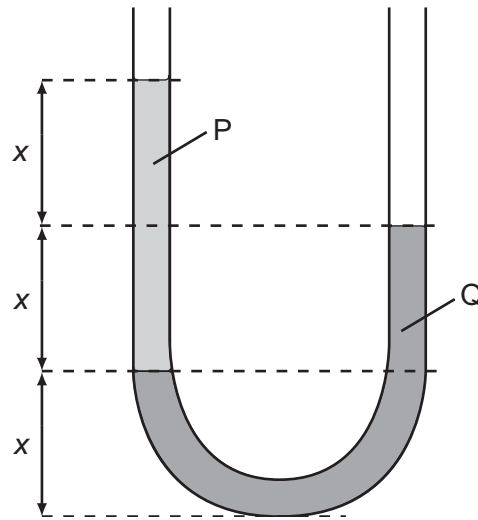

What is the ratio $\frac{\text{density of P}}{\text{density of Q}}$?

- A $\frac{1}{2}$ B $\frac{2}{3}$ C $\frac{3}{2}$ D 2
- 21 Which two substances are normally both crystalline?
- A copper and diamond
 B copper and glass
 C diamond and glass
 D diamond and rubber
- 22 The table shows a load applied to four wires and the cross-sectional area of each.
- Which of the wires is subjected to the greatest stress?

	load / N	cross-sectional area / mm ²
A	1500	0.25
B	2000	1.0
C	3000	0.56
D	5000	2.3

- 23 The force F required to extend a sample of rubber by a distance x is found to vary as shown.

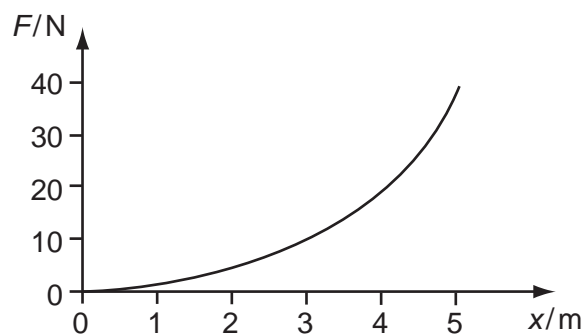

The energy stored in the rubber for an extension of 5 m is

- A** less than 100 J.
B 100 J.
C between 100 J and 200 J.
D more than 200 J.
- 24 Which of the following is a longitudinal wave?
- A** a light wave travelling through air
B a radio wave from a broadcasting station
C a ripple on the surface of water
D a sound wave travelling through air
- 25 A stationary sound wave is set up along the line joining two loudspeakers.
- Which measurement is sufficient on its own to enable you to deduce the wavelength of the wave?
- A** the amplitude of the sound wave
B the distance between the two loudspeakers
C the distance between two adjacent antinodes
D the frequency of the sound wave
- 26 A wave of amplitude 20 mm has intensity I_X . Another wave of the same frequency but of amplitude 5 mm has intensity I_Y .

What is $\frac{I_X}{I_Y}$?

- A** 2 **B** 4 **C** 16 **D** 256

- 27 The diagram represents a stationary wave on a stretched string.

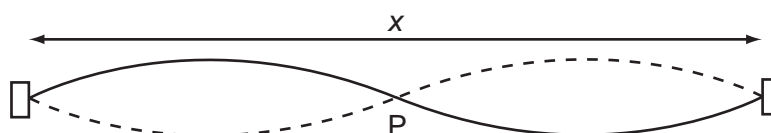

What is represented by point P and by the length x ?

	point P	length x
A	antinode	one wavelength
B	antinode	two wavelengths
C	node	one wavelength
D	node	two wavelengths

- 28 Fringes of separation y are observed on a screen 1.00 m from a Young's slit arrangement that is illuminated by yellow light of wavelength 600 nm.

At which distance from the slits would fringes of the same separation y be observed when using blue light of wavelength 400 nm?

- A** 0.33 m **B** 0.67 m **C** 0.75 m **D** 1.50 m
- 29 Two parallel, conducting plates with air between them are placed close to one another. The top plate is given a negative charge and the bottom one is earthed.

Which diagram best represents the distribution of charges and the field in this situation?

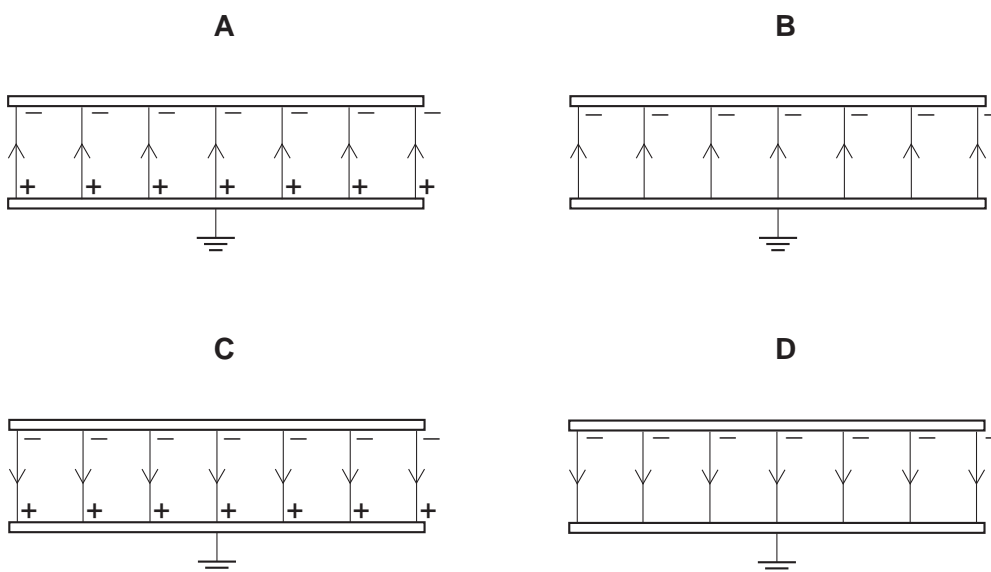

- 30 In a uniform electric field, which statement is correct?
- A All charged particles experience the same force.
 - B All charged particles move with the same velocity.
 - C All electric field lines are directed towards positive charges.
 - D All electric field lines are parallel.
- 31 Which of the following describes the electric potential difference between two points in a wire that carries a current?
- A the force required to move a unit positive charge between the points
 - B the ratio of the energy dissipated between the points to the current
 - C the ratio of the power dissipated between the points to the current
 - D the ratio of the power dissipated between the points to the charge moved

- 32 The diagram shows four heaters and the current in each.

Which heater has the greatest power dissipation?

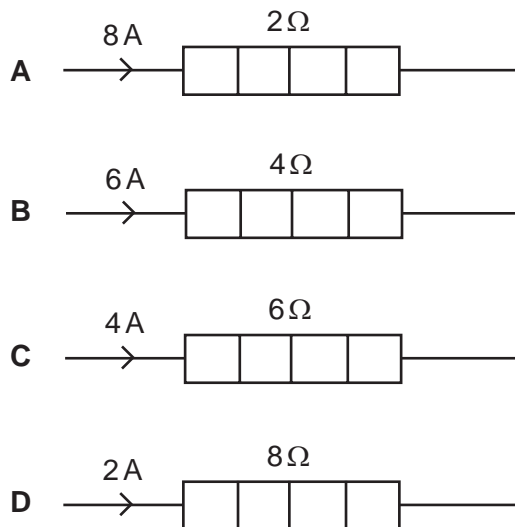

- 33 When a potential difference V is applied between the ends of a wire of diameter d and length l , the current in the wire is I .

What is the current when a potential difference of $2V$ is applied between the ends of a wire of the same material of diameter $2d$ and the length $2l$? Assume that the temperature of the wire remains constant.

- A I
- B $2I$
- C $4I$
- D $8I$

- 34 The resistance of a thermistor decreases significantly as its temperature increases.

The thermistor is kept in air. The air is at room temperature.

Which graph best represents the way in which the current I in the thermistor depends upon the potential difference V across it?

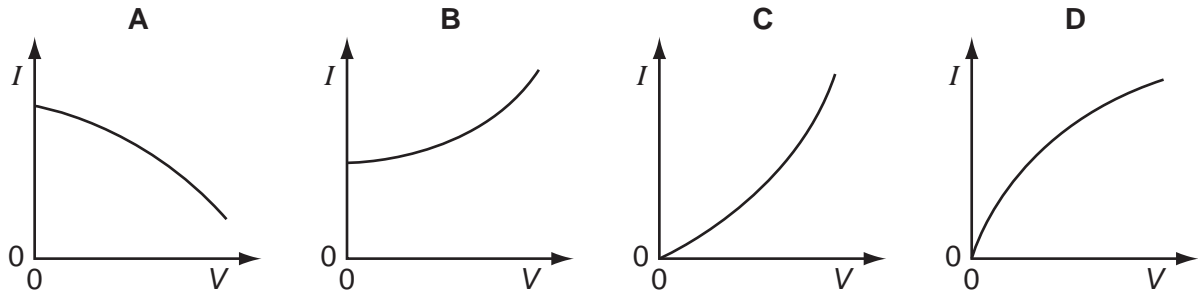

- 35 The diagram shows a junction in a circuit where three wires P, Q and R meet. The currents in P and Q are 1 A and 3 A respectively, in the directions shown.

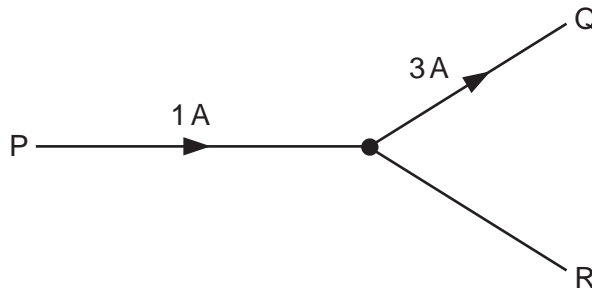

How many coulombs of charge pass a given point in wire R in 5 seconds?

- A** 0.4 **B** 0.8 **C** 2 **D** 10

- 36 The diagram shows a potential divider circuit designed to provide a variable output p.d.

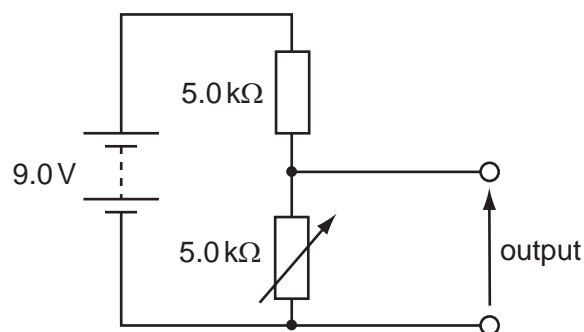

Which gives the available range of output p.d?

	maximum output	minimum output
A	3.0 V	0
B	4.5 V	0
C	9.0 V	0
D	9.0 V	4.5 V

- 37 In the circuit shown, the ammeters have negligible resistance and the voltmeters have infinite resistance.

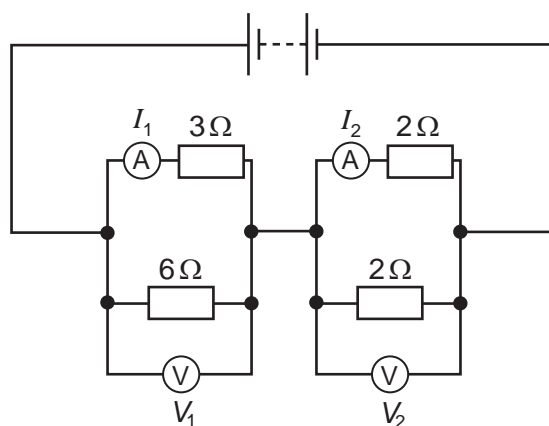

The readings on the meters are I_1 , I_2 , V_1 and V_2 , as labelled on the diagram.

Which is correct?

- A** $I_1 > I_2$ and $V_1 > V_2$
B $I_1 > I_2$ and $V_1 < V_2$
C $I_1 < I_2$ and $V_1 > V_2$
D $I_1 < I_2$ and $V_1 < V_2$

- 38 The symbol ${}_{32}^{77}\text{Ge}$ represents a nuclide of germanium that decays to a nuclide of arsenic (As) by emitting a β -particle.

What is the symbol of this arsenic nuclide?

- A ${}_{32}^{76}\text{As}$ B ${}_{32}^{78}\text{As}$ C ${}_{31}^{78}\text{As}$ D ${}_{33}^{77}\text{As}$

- 39 The table shows three properties of different types of ionising radiation.

	X	Y	Z
charge	0	$-1e$	$+2e$
mass	0	$\frac{1}{1840}u$	$4u$
speed	c	$\sim 0.9c$	$\sim 0.1c$

What are the radiations X, Y and Z?

	X	Y	Z
A	alpha	beta	X-rays
B	gamma	alpha	beta
C	gamma	beta	alpha
D	X-rays	alpha	beta

- 40 Which conclusion can be drawn from the results of the experiment showing the scattering of α -particles by gold foil?
- A Electrons orbit the atomic nucleus in well-defined paths.
- B Nuclei of different isotopes contain different numbers of neutrons.
- C The atomic nucleus contains protons and neutrons.
- D The nucleus is very small compared with the size of the atom.

BLANK PAGE

BLANK PAGE

Every reasonable effort has been made to trace all copyright holders where the publishers (i.e. UCLES) are aware that third-party material has been reproduced. The publishers would be pleased to hear from anyone whose rights they have unwittingly infringed.

University of Cambridge International Examinations is part of the University of Cambridge Local Examinations Syndicate (UCLES), which is itself a department of the University of Cambridge.