



PHYSICS

9702/13

Paper 1 Multiple Choice

May/June 2013

1 hour

Additional Materials: Multiple Choice Answer Sheet
Soft clean eraser
Soft pencil (type B or HB is recommended)

* 2 7 1 1 8 5 6 2 5 1 *

READ THESE INSTRUCTIONS FIRST

Write in soft pencil.

Do not use staples, paper clips, highlighters, glue or correction fluid.

Write your name, Centre number and candidate number on the Answer Sheet in the spaces provided unless this has been done for you.

DO NOT WRITE IN ANY BARCODES.

There are **forty** questions on this paper. Answer **all** questions. For each question there are four possible answers **A, B, C** and **D**.

Choose the **one** you consider correct and record your choice in **soft pencil** on the separate Answer Sheet.

Read the instructions on the Answer Sheet very carefully.

Each correct answer will score one mark. A mark will not be deducted for a wrong answer.

Any working should be done in this booklet.

Electronic calculators may be used.

This document consists of **26** printed pages and **2** blank pages.



Data

speed of light in free space,	$c = 3.00 \times 10^8 \text{ m s}^{-1}$
permeability of free space,	$\mu_0 = 4\pi \times 10^{-7} \text{ H m}^{-1}$
permittivity of free space,	$\epsilon_0 = 8.85 \times 10^{-12} \text{ F m}^{-1}$ $(\frac{1}{4\pi\epsilon_0} = 8.99 \times 10^9 \text{ m F}^{-1})$
elementary charge,	$e = 1.60 \times 10^{-19} \text{ C}$
the Planck constant,	$h = 6.63 \times 10^{-34} \text{ J s}$
unified atomic mass constant,	$u = 1.66 \times 10^{-27} \text{ kg}$
rest mass of electron,	$m_e = 9.11 \times 10^{-31} \text{ kg}$
rest mass of proton,	$m_p = 1.67 \times 10^{-27} \text{ kg}$
molar gas constant,	$R = 8.31 \text{ J K}^{-1} \text{ mol}^{-1}$
the Avogadro constant,	$N_A = 6.02 \times 10^{23} \text{ mol}^{-1}$
the Boltzmann constant,	$k = 1.38 \times 10^{-23} \text{ J K}^{-1}$
gravitational constant,	$G = 6.67 \times 10^{-11} \text{ N m}^2 \text{ kg}^{-2}$
acceleration of free fall,	$g = 9.81 \text{ m s}^{-2}$

Formulae

uniformly accelerated motion,	$s = ut + \frac{1}{2}at^2$ $v^2 = u^2 + 2as$
work done on/by a gas,	$W = p\Delta V$
gravitational potential,	$\phi = -\frac{Gm}{r}$
hydrostatic pressure,	$p = \rho gh$
pressure of an ideal gas,	$p = \frac{1}{3}\frac{Nm}{V}\langle c^2 \rangle$
simple harmonic motion,	$a = -\omega^2 x$
velocity of particle in s.h.m.,	$v = v_0 \cos \omega t$ $v = \pm \omega \sqrt{(x_0^2 - x^2)}$
electric potential,	$V = \frac{Q}{4\pi\epsilon_0 r}$
capacitors in series,	$1/C = 1/C_1 + 1/C_2 + \dots$
capacitors in parallel,	$C = C_1 + C_2 + \dots$
energy of charged capacitor,	$W = \frac{1}{2}QV$
resistors in series,	$R = R_1 + R_2 + \dots$
resistors in parallel,	$1/R = 1/R_1 + 1/R_2 + \dots$
alternating current/voltage,	$x = x_0 \sin \omega t$
radioactive decay,	$x = x_0 \exp(-\lambda t)$
decay constant,	$\lambda = \frac{0.693}{t_{\frac{1}{2}}}$

- 1 The diagram shows a displacement vector.

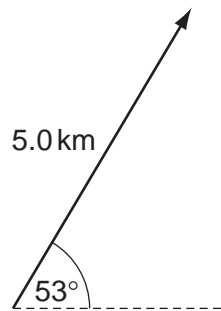

What is the vertical component of this displacement vector?

- A 3.0 km B 4.0 km C 5.0 km D 6.6 km
- 2 What is the unit of power, expressed in SI base units?
- A $\text{kg m}^2 \text{s}^{-3}$ B kg m s^{-3} C kg m s^{-2} D $\text{kg m}^2 \text{s}^{-1}$
- 3 Which statement is **incorrect** by a factor of 100 or more?
- A Atmospheric pressure is about 1×10^5 Pa.
- B Light takes 5×10^2 s to reach us from the Sun.
- C The frequency of ultra-violet light is 3×10^{12} Hz.
- D The life-span of a man is about 2×10^9 s.

Space for working

- 4 A cyclist is travelling due south with velocity u . The wind is blowing from the north-east with velocity w .

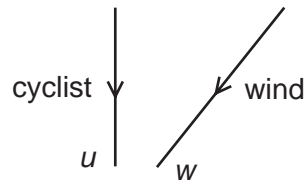

The wind has a velocity v relative to the cyclist, where $v = w - u$.

Which vector diagram shows the magnitude and direction of velocity v ?

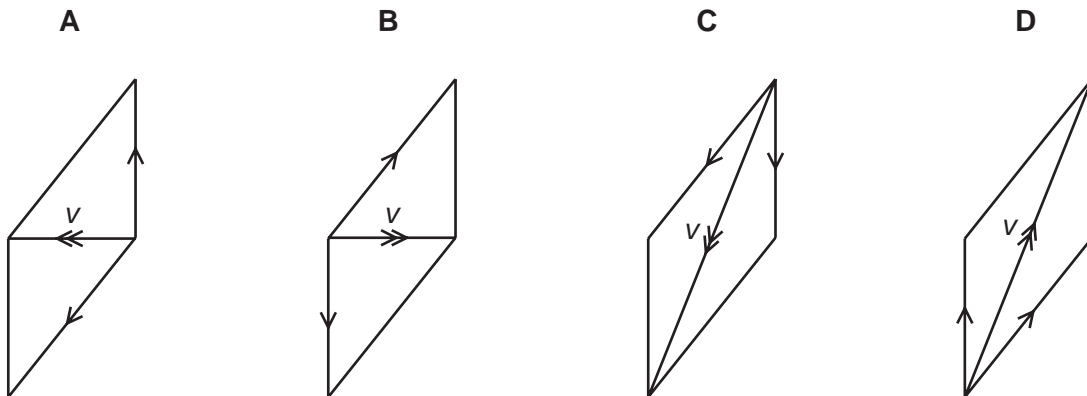

- 5 A student takes measurements of the current in a resistor of constant resistance and the potential difference (p.d.) across it. The readings are then used to plot a graph of current against p.d.

There is a systematic error in the current readings.

How could this be identified from the graph?

- A At least one anomalous data point can be identified.
- B The data points are scattered about the straight line of best fit.
- C The graph is a curve, not a straight line.
- D The straight line graph does not pass through the origin.

Space for working

- 6 The diagram shows the stem of a Celsius thermometer, marked to show initial and final temperature values.

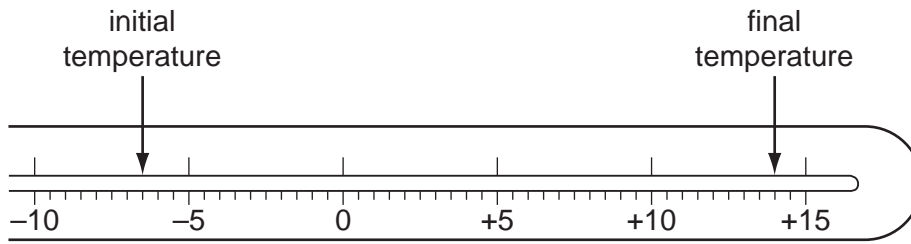

What is the temperature change expressed to an appropriate number of significant figures?

- A 14 °C B 20.5 °C C 21 °C D 22.0 °C
- 7 A double-ended launching device fires two identical steel balls X and Y at exactly the same time. The diagram shows the initial velocities of the balls. They are both launched horizontally, but Y has greater speed.

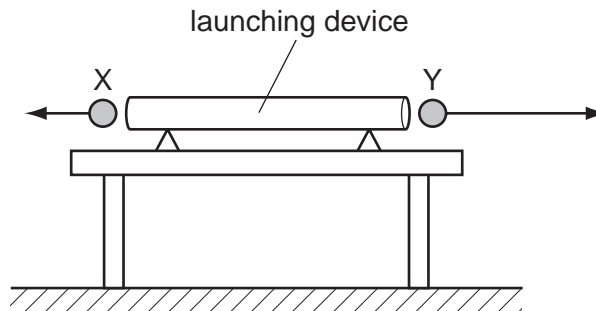

Which statement explains what an observer would see?

- A Both X and Y reach the ground simultaneously, because air resistance will cause both to have the same final speed.
- B Both X and Y reach the ground simultaneously, because gravitational acceleration is the same for both.
- C X reaches the ground before Y, because X lands nearer to the launcher.
- D Y reaches the ground before X, because Y has greater initial speed.

Space for working

- 8 At time $t = 0$, a body moves from rest with constant acceleration in a straight line. At time t , the body is distance s from its rest position.

A graph is drawn of s against t^2 , as shown.

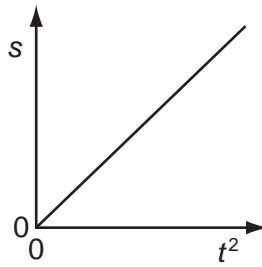

Which statement describes the acceleration of the body?

- A It is equal to half the value of the gradient of the graph.
- B It is equal to the value of the gradient of the graph.
- C It is equal to twice the value of the gradient of the graph.
- D It is equal to the reciprocal of the gradient of the graph.

Space for working

- 9 A lift (elevator) consists of a passenger car supported by a cable which runs over a light, frictionless pulley to a balancing weight. The balancing weight falls as the passenger car rises.

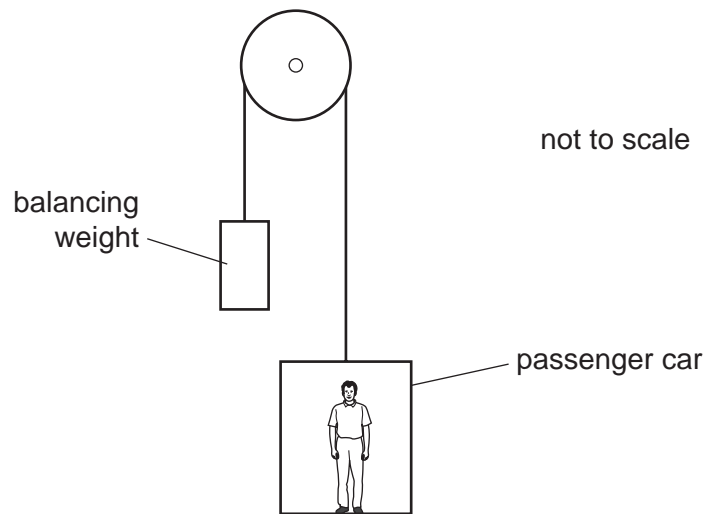

Some masses are shown in the table.

	mass / kg
passenger car	520
balancing weight	640
passenger	80

What is the magnitude of the acceleration of the car when carrying just one passenger and when the pulley is free to rotate?

- A** 0.032 ms^{-2} **B** 0.32 ms^{-2} **C** 0.61 ms^{-2} **D** 0.65 ms^{-2}

Space for working

- 10 A stationary nucleus has nucleon number A .

The nucleus decays by emitting a proton with speed v to form a new nucleus with speed u . The new nucleus and the proton move away from one another in opposite directions.

Which equation gives v in terms of A and u ?

- A $v = \left(\frac{A}{4} - 1\right)u$
 B $v = (A - 1)u$
 C $v = Au$
 D $v = (A + 1)u$

- 11 Two spheres travel along the same line with velocities u_1 and u_2 . They collide and after collision their velocities are v_1 and v_2 .



Which collision is **not** elastic?

	u_1/ms^{-1}	u_2/ms^{-1}	v_1/ms^{-1}	v_2/ms^{-1}
A	2	-5	-5	-2
B	3	-3	0	6
C	3	-2	1	6
D	5	2	3	6

Space for working

- 12 The diagrams show a negative electric charge situated in a uniform electric field and a mass situated in a uniform gravitational field.

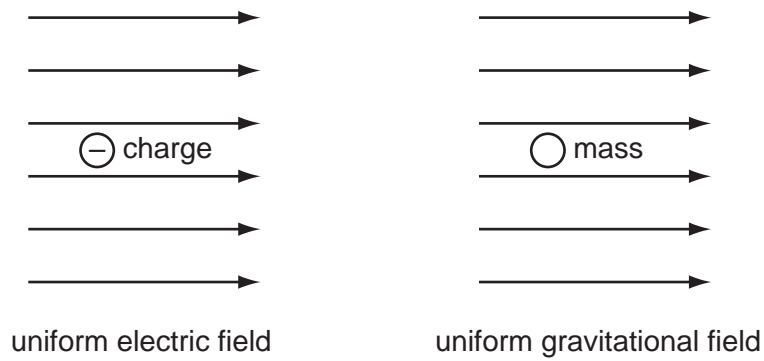

Which row shows the directions of the forces acting on the charge and on the mass?

	charge	mass
A		
B		
C		
D		

Space for working

- 13 A wooden block rests on a rough board. The end of the board is then raised until the block slides down the plane of the board at constant velocity v .

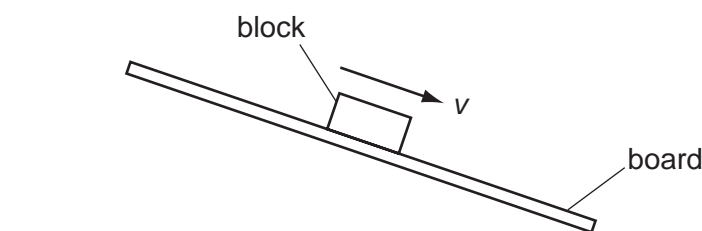

Which row describes the forces acting on the block when sliding with constant velocity?

	frictional force on block	resultant force on block
A	down the plane	down the plane
B	down the plane	zero
C	up the plane	down the plane
D	up the plane	zero

- 14 A ball of mass m is thrown up to height h in air with an initial velocity v , as shown.

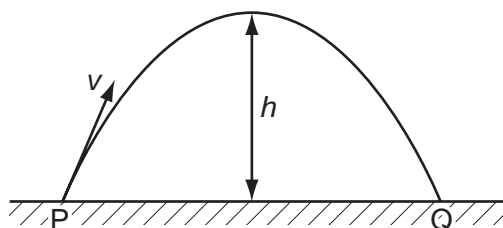

Air resistance is considered negligible. The acceleration of free fall is g .

What is the **total** work done by the gravitational force on the ball during its flight from P to Q?

- A** zero **B** $\frac{1}{2}mv^2$ **C** mgh **D** $2mgh$
- 15 A spring of unextended length 40 mm is suspended from a fixed point. A load of 16 N is applied to the free end of the spring. This causes the spring to extend so that its final length is five times its original length. The spring obeys Hooke's Law.

What is the energy stored in the spring due to this extension?

- A** 1.3 J **B** 1.6 J **C** 2.6 J **D** 3.2 J

Space for working

- 16 The diagram shows an arrangement used to find the output power of an electric motor.

The wheel attached to the motor's axle has a circumference of 0.5 m and the belt which passes over it is stationary when the weights have the values shown.

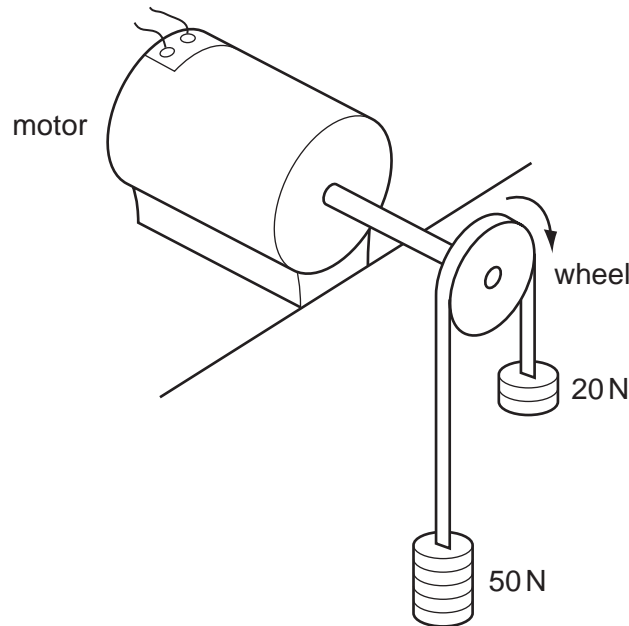

If the wheel is making 20 revolutions per second, what is the output power of the motor?

- A 300 W B 500 W C 600 W D 700 W
- 17 Ice at a temperature of 0°C is a rare example of a solid that floats on its liquid form, in this case water, when they are both at the same temperature.

What is the explanation for this?

- A The average speed of the molecules in the ice is greater than the average speed of the molecules in the water.
- B The average speed of the molecules in the water is greater than the average speed of the molecules in the ice.
- C The mean separation of the molecules in the ice is greater than the mean separation of the molecules in the water.
- D The mean separation of the molecules in the water is greater than the mean separation of the molecules in the ice.

Space for working

18 The formula for hydrostatic pressure is $p = \rho gh$.

Which equation, or principle of physics, is used in the derivation of this formula?

- A density = $\frac{\text{mass}}{\text{volume}}$
- B potential energy = mgh
- C atmospheric pressure decreases with height
- D density increases with depth

19 The diagram shows a large crane on a construction site lifting a cube-shaped load.

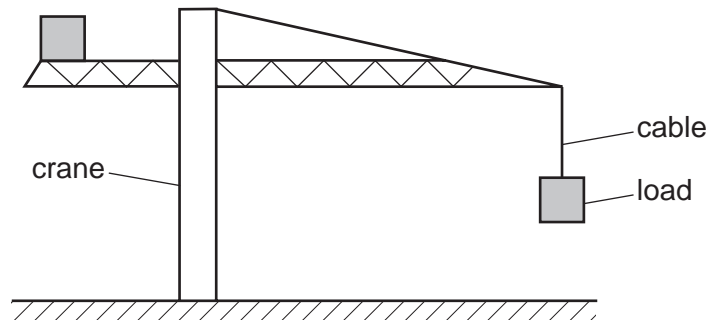

A model is made of the crane, its load and the cable supporting the load.

The material used for each part of the model is the same as that in the full-size crane, cable and load. The model is one tenth full-size in all linear dimensions.

What is the ratio $\frac{\text{extension of the cable on the full-size crane}}{\text{extension of the cable on the model crane}}$?

- A 10^0
- B 10^1
- C 10^2
- D 10^3

Space for working

- 20 Which graph represents the force-extension relationship of a rubber band that is stretched almost to its breaking point?

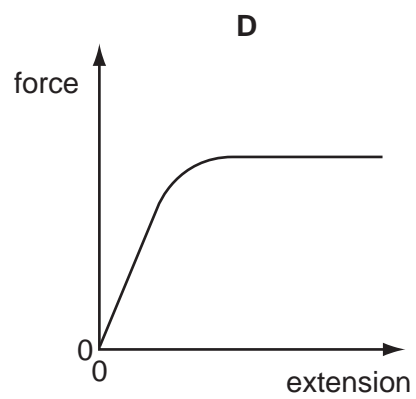
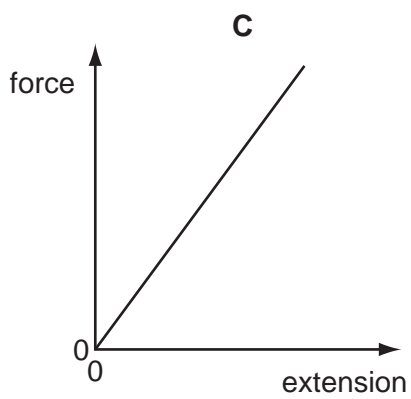
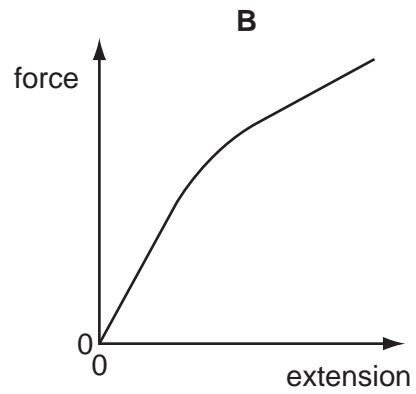
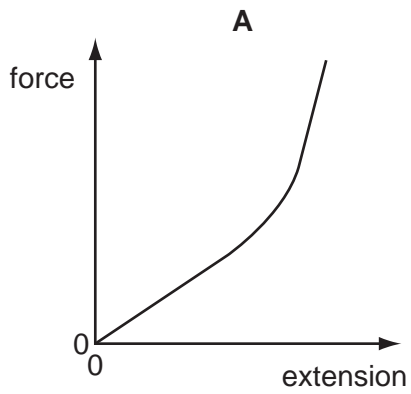

Space for working

- 21 A spring is stretched over a range within which elastic deformation occurs. Its spring constant is 3.0 N cm^{-1} .

Which row, for the stated applied force, gives the correct extension and strain energy?

	force /N	extension /cm	strain energy /mJ
A	3.0	1.0	1.5
B	6.0	2.0	120
C	12.0	3.0	180
D	24.0	8.0	960

- 22 Which statement about different types of electromagnetic wave is correct?

- A** The frequency of infra-red waves is less than the frequency of blue light.
B The frequency of radio waves is greater than the frequency of gamma rays.
C The wavelength of red light is less than the wavelength of ultraviolet waves.
D The wavelength of X-rays is greater than the wavelength of microwaves.

- 23 Orange light has a wavelength of 600 nm.

What is the frequency of this light?

- A** 180 GHz **B** 180 Hz **C** 500 THz **D** 500 kHz

Space for working

24 Electromagnetic waves of wavelength λ and frequency f travel at speed c in a vacuum.

What describes the wavelength and speed of electromagnetic waves of frequency $f/2$?

	wavelength	speed in a vacuum
A	$\lambda/2$	$c/2$
B	$\lambda/2$	c
C	2λ	c
D	2λ	$2c$

25 When the liquid crystal display of a calculator is observed through a polarising film, the display changes as the film is rotated.

Which property describes the radiation from the calculator display?

- A** unpolarised
- B** a longitudinal wave
- C** a transverse wave
- D** a wave with a 3 cm wavelength

Space for working

26 A sound wave has displacement y at distance x from its source at time t .

Which graph correctly shows the amplitude a and the wavelength λ of the wave?

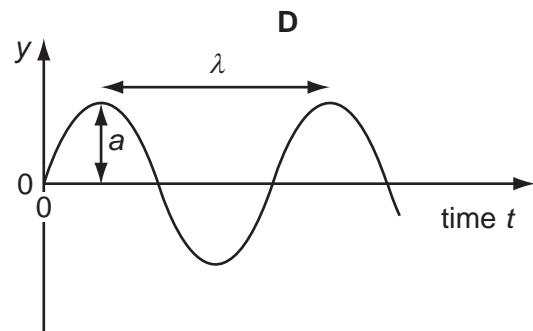
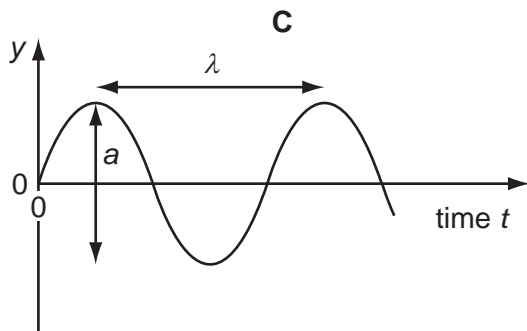
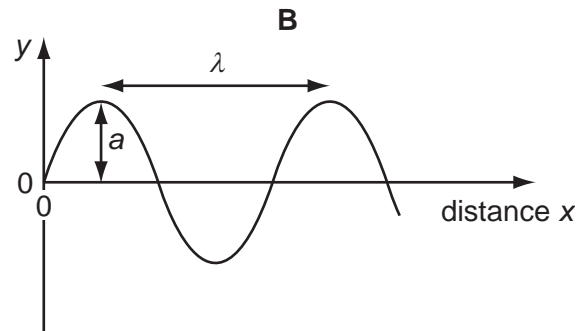
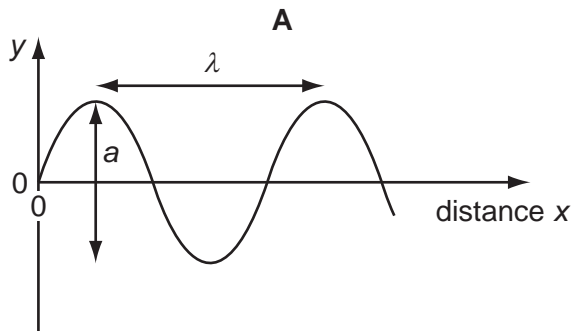

27 A parallel beam of red light of wavelength 700 nm is incident normally on a diffraction grating that has 400 lines per millimetre.

What is the total number of transmitted maxima?

A 3

B 4

C 6

D 7

Space for working

- 28 The diagram shows a standing wave on a string. The standing wave has three nodes N_1 , N_2 and N_3 .

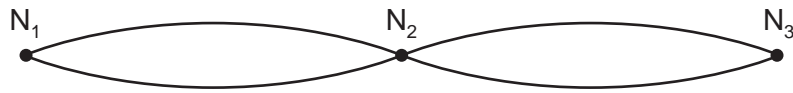

Which statement is correct?

- A All points on the string vibrate in phase.
 B All points on the string vibrate with the same amplitude.
 C Points equidistant from N_2 vibrate with the same frequency and in phase.
 D Points equidistant from N_2 vibrate with the same frequency and the same amplitude.
- 29 Two metal plates are held horizontal and parallel, 5.0 cm apart. The plates are at potentials of +100 V and +20 V.

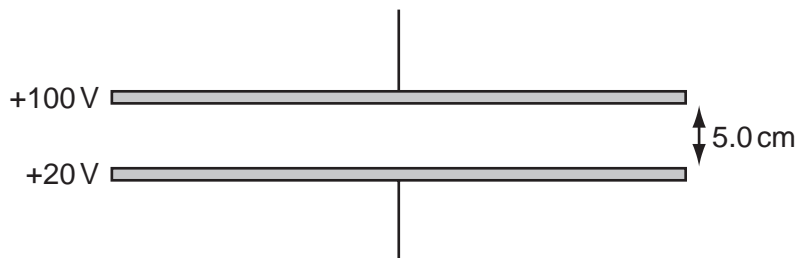

What is the force experienced by an electron in the electric field between the plates?

- A 2.6×10^{-18} N
 B 3.8×10^{-18} N
 C 2.6×10^{-16} N
 D 3.8×10^{-16} N

Space for working

- 30 The diagram shows the path of a charged particle through a uniform electric field, having vertical field lines.

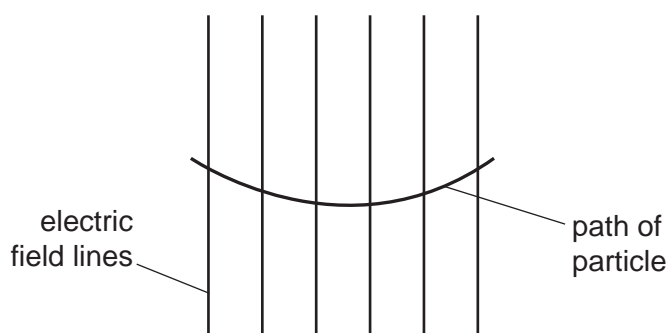

What could give a path of this shape?

- A a positive charge travelling left to right in a field directed downwards
 - B a positive charge travelling right to left in a field directed downwards
 - C a negative charge travelling right to left in a field directed upwards
 - D a negative charge travelling left to right in a field directed downwards
- 31 Two cells X and Y are connected in series with a resistor of resistance 9.0Ω , as shown.

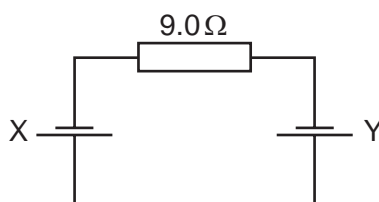

Cell X has an electromotive force (e.m.f.) of 1.0V and an internal resistance of 1.0Ω . Cell Y has an e.m.f. of 2.0V and an internal resistance of 2.0Ω .

What is the current in the circuit?

- A 0.25A
- B 0.17A
- C 0.10A
- D 0.083A

Space for working

- 32 The circular cross-sectional area of a metal wire varies along its length. There is a current in the wire. The narrow end of the wire is at a reference potential of zero.

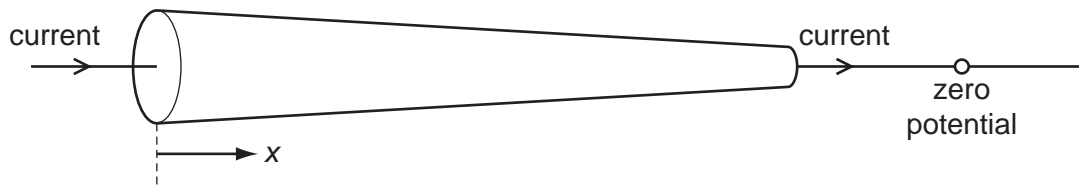

Which graph best represents the variation with distance x along the wire of the potential difference V relative to the reference zero?

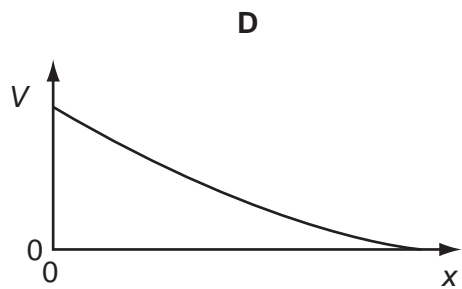
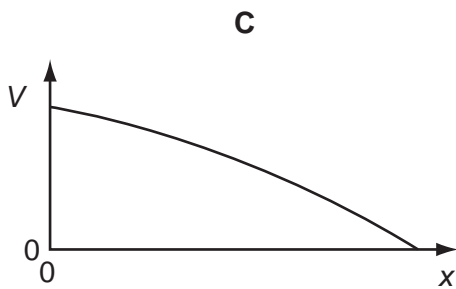
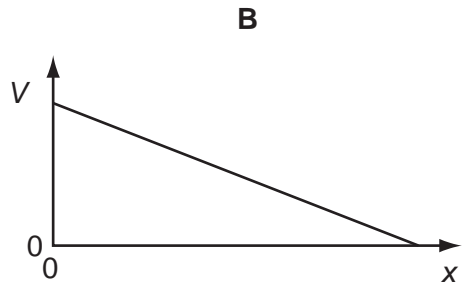
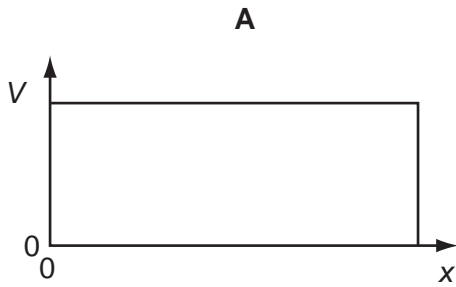

Space for working

33 The graph shows how current I varies with voltage V for a filament lamp.

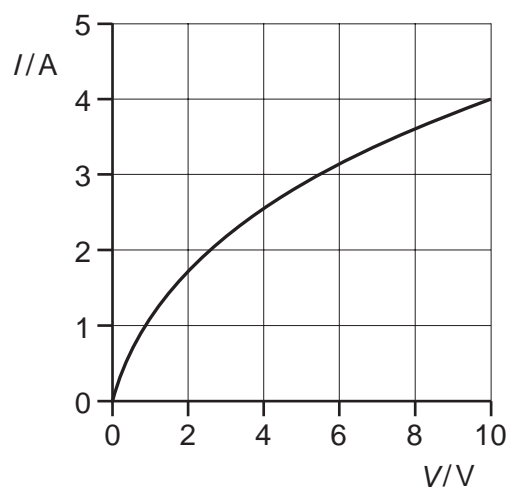

Since the graph is not a straight line, the resistance of the lamp varies with V .

Which row gives the correct resistance at the stated value of V ?

	V/V	R/Ω
A	2.0	1.5
B	4.0	3.2
C	6.0	1.9
D	8.0	0.9

Space for working

- 34 An electric power cable consists of six copper wires c surrounding a steel core s .

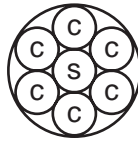

A length of 1.0 km of one of the copper wires has a resistance of $10\ \Omega$ and 1.0 km of the steel core has a resistance of $100\ \Omega$.

What is the approximate resistance of a 1.0 km length of the power cable?

- A $0.61\ \Omega$ B $1.6\ \Omega$ C $160\ \Omega$ D $610\ \Omega$
- 35 The diagram shows a length of track from a model railway connected to a battery, a resistor and a relay coil.

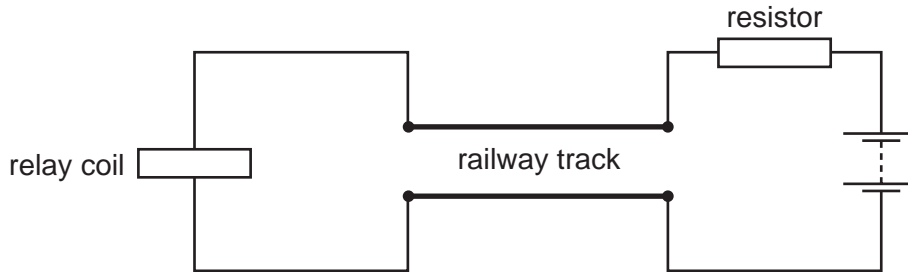

With no train present, there is a current in the relay coil which operates a switch to turn on a light. When a train occupies the section of track, most of the current flows through the wheels and axles of the train in preference to the relay coil. The switch in the relay turns off the light.

Why is a resistor placed between the battery and the track?

- A to limit the heating of the wheels of the train
 B to limit the energy lost in the relay coil when a train is present
 C to prevent a short circuit of the battery when a train is present
 D to protect the relay when a train is present

Space for working

- 36 A 12V battery is in series with an ammeter, a 2Ω fixed resistor and a $0-10\Omega$ variable resistor. A high-resistance voltmeter is connected across the fixed resistor.

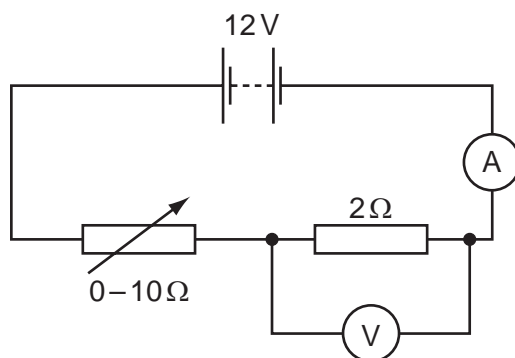

The resistance of the variable resistor is changed from zero to its maximum value.

Which graph shows how the potential difference (p.d.) measured by the voltmeter varies with the current measured by the ammeter?

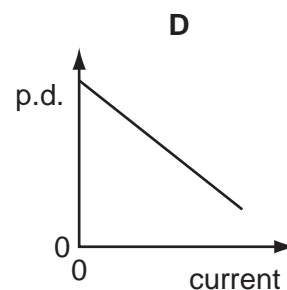
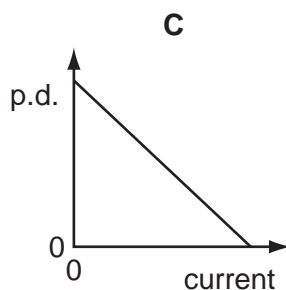
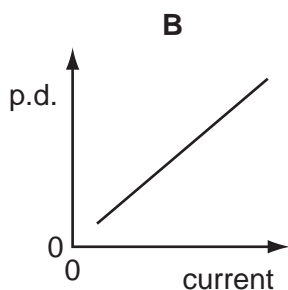
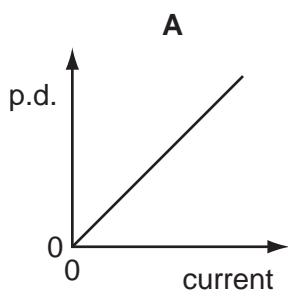

Space for working

37 In the circuit shown, the battery and ammeter each have negligible resistance.

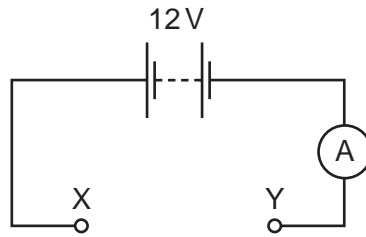

The following combinations of resistors are placed in turn between the terminals X and Y of the circuit.

Which combination would give an ammeter reading of 8 A?

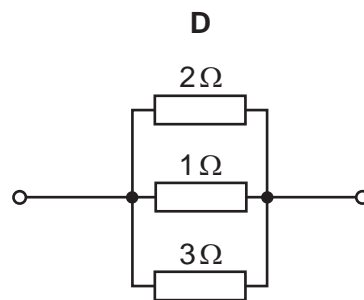
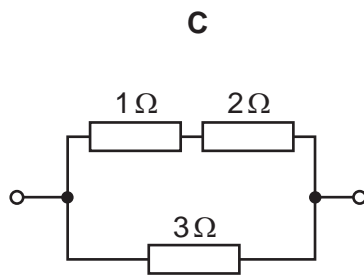
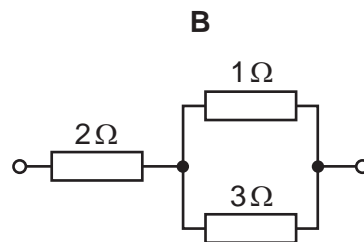
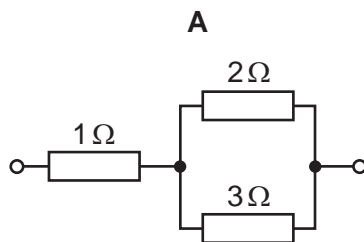

Space for working

- 38 Scientists investigating the count rate from a radioactive source observed that the count rate fluctuates.

What do these fluctuations imply about the nature of radioactive decay?

- A It involves atomic nuclei.
- B It is predictable.
- C It is random.
- D It is spontaneous.

- 39 The decay of a nucleus of neptunium is accompanied by the emission of a β -particle and γ -radiation.

What effect (if any) does this decay have on the proton number and on the nucleon number of the nucleus?

	proton number	nucleon number
A	increases	decreases
B	decreases	increases
C	unchanged	decreases
D	increases	unchanged

Space for working

40 A radioactive nucleus is formed by β -decay. This nucleus then decays by α -emission.

Which graph of nucleon number N plotted against proton number Z shows the β -decay followed by the α -emission?

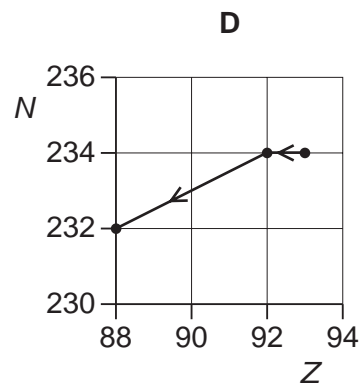
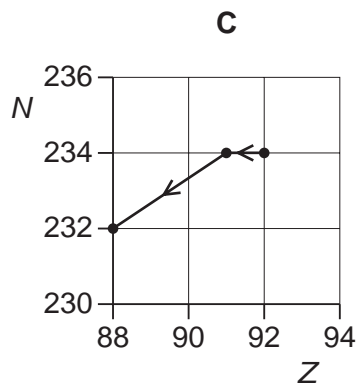
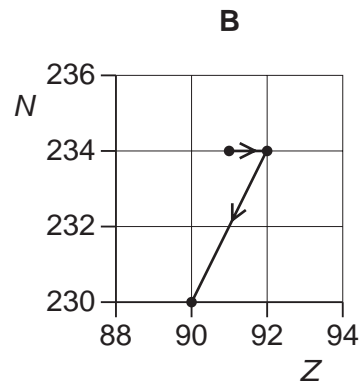
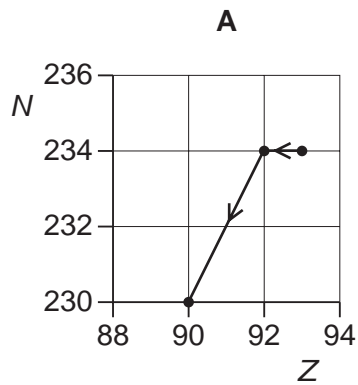

Space for working

BLANK PAGE

Permission to reproduce items where third-party owned material protected by copyright is included has been sought and cleared where possible. Every reasonable effort has been made by the publisher (UCLES) to trace copyright holders, but if any items requiring clearance have unwittingly been included, the publisher will be pleased to make amends at the earliest possible opportunity.

University of Cambridge International Examinations is part of the Cambridge Assessment Group. Cambridge Assessment is the brand name of University of Cambridge Local Examinations Syndicate (UCLES), which is itself a department of the University of Cambridge.