



UNIVERSITY OF CAMBRIDGE INTERNATIONAL EXAMINATIONS
General Certificate of Education
Advanced Subsidiary Level and Advanced Level

BIOLOGY

9700/12

Paper 1 Multiple Choice

October/November 2011

1 hour

Additional Materials: Multiple Choice Answer Sheet
 Soft clean eraser
 Soft pencil (type B or HB is recommended)

READ THESE INSTRUCTIONS FIRST

Write in soft pencil.

Do not use staples, paper clips, highlighters, glue or correction fluid.

Write your name, Centre number and candidate number on the Answer Sheet in the spaces provided unless this has been done for you.

There are **forty** questions on this paper. Answer **all** questions. For each question there are four possible answers **A, B, C** and **D**.

Choose the **one** you consider correct and record your choice in **soft pencil** on the separate Answer Sheet.

Read the instructions on the Answer Sheet very carefully.

Each correct answer will score one mark. A mark will not be deducted for a wrong answer.

Any rough working should be done in this booklet.

This document consists of **18** printed pages and **2** blank pages.



1 What is the diameter of a typical plant cell?

- A 1.0×10^2 nm
- B 4.0×10^2 nm
- C 4.0×10^0 μ m
- D 4.0×10^1 μ m

2 Where would cisternae be found in a cell?

- 1 endoplasmic reticulum
- 2 Golgi apparatus
- 3 mitochondrion

- A 1 and 2 B 1 and 3 C 2 and 3 D 1 only

3 Ribosomes exist as separate subunits that bind together during protein synthesis.

What do these subunits consist of?

- A mRNA and protein
- B mRNA and tRNA
- C rRNA and protein
- D rRNA and tRNA

4 Which cell components contain mRNA?

- 1 chloroplast
- 2 mitochondrion
- 3 nucleus
- 4 rough endoplasmic reticulum

- A 1, 2, 3 and 4
- B 1, 2 and 3 only
- C 2, 3 and 4 only
- D 3 and 4 only

- 5 The diagram shows a stage micrometer on which the small divisions are 0.1 mm. It is viewed through an eyepiece containing a graticule.

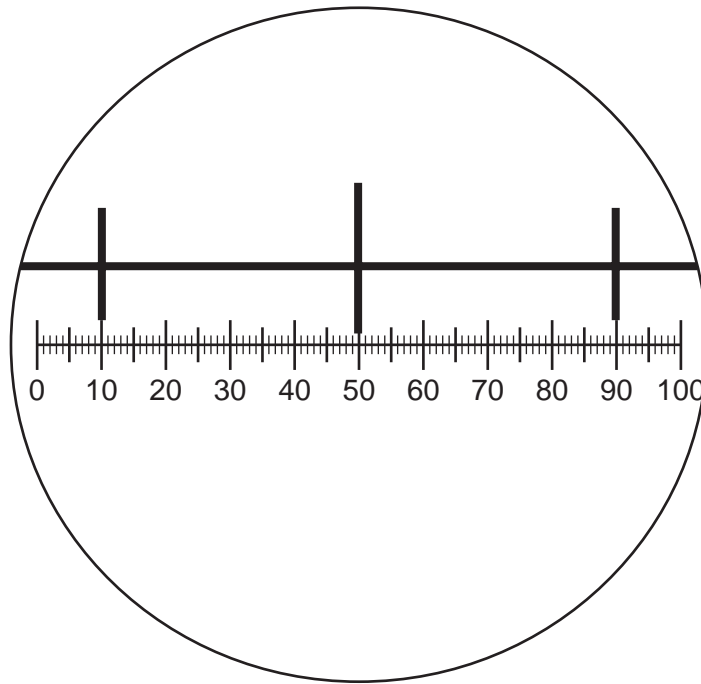

The stage micrometer is replaced by a slide of a plant cell.

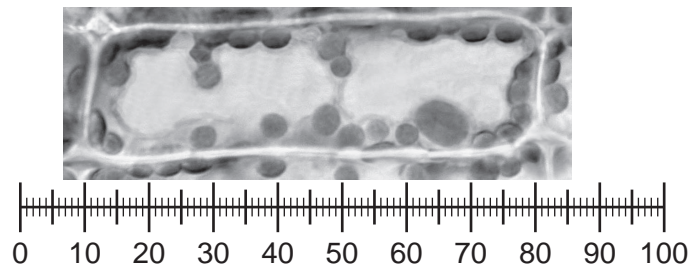

What is the width of a chloroplast?

- A** 0.5 mm **B** 10 μm **C** 50 μm **D** 100 μm
- 6 Which processes occur in eukaryotes and prokaryotes?
- 1 hydrolysis
 - 2 mitosis
 - 3 transcription
 - 4 translation
- A** 1, 2 and 3 **B** 1, 2 and 4 **C** 1, 3 and 4 **D** 2, 3 and 4

- 7 High concentrations of urea break all bonds, except covalent bonds, in protein molecules.

Which level of protein structure would remain unchanged when a protein is treated with urea?

- A primary
 - B secondary
 - C tertiary
 - D quaternary
- 8 Two disaccharides are cellobiose and sucrose. Cellobiose is formed from two molecules of glucose, whilst sucrose is formed from fructose and glucose.

Which row shows the molecular formulae of the two disaccharides?

	cellobiose	sucrose
A	$C_{12}H_{22}O_{11}$	$C_{12}H_{22}O_{11}$
B	$C_{12}H_{22}O_{11}$	$C_{12}H_{24}O_{12}$
C	$C_{12}H_{24}O_{12}$	$C_{12}H_{22}O_{11}$
D	$C_{12}H_{24}O_{12}$	$C_{12}H_{24}O_{12}$

9 The diagram shows part of a carbohydrate molecule.

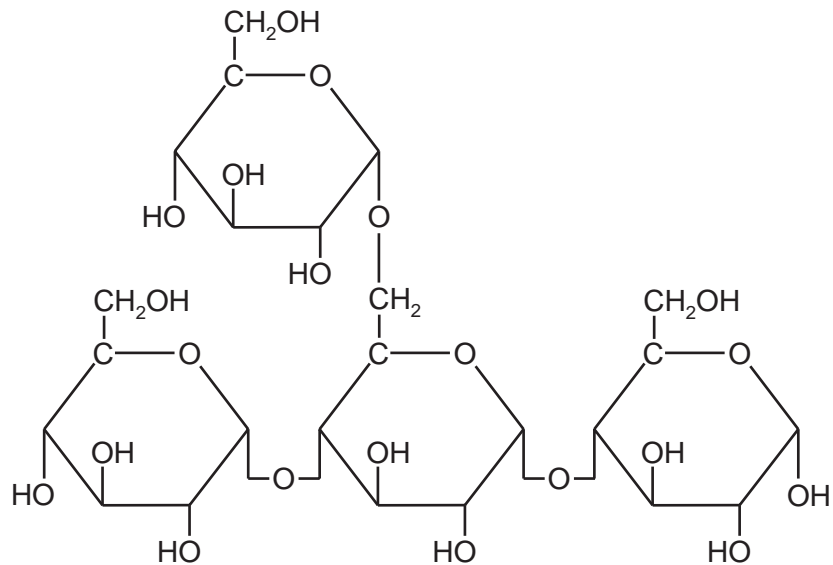

Which polymers could this be part of?

- 1 amylopectin
- 2 amylose
- 3 glycogen
- 4 starch

- A** 1, 2 and 3
B 1, 3 and 4
C 2 and 4 only
D 3 and 4 only

10 Solutions of biological molecules are tested for sugars. The table shows the colours of the solutions after testing.

solution	heated with Benedict's solution	boiled with hydrochloric acid, neutralised, then heated with Benedict's solution
1	blue	orange
2	orange	green
3	yellow	red

Which may contain non-reducing sugars?

- A** 1, 2 and 3 **B** 1 and 2 only **C** 1 and 3 only **D** 2 and 3 only

11 When a lake begins to freeze, which properties of water are needed for fish to survive?

- 1 Water has a high surface tension.
- 2 Water has a high latent heat of vaporisation.
- 3 Water has a high thermal capacity.
- 4 Water has its maximum density at 4 °C.

	1	2	3	4	
A	✓	✓	✓	x	key ✓ = needed x = not needed
B	✓	x	✓	x	
C	x	✓	x	✓	
D	x	x	✓	✓	

12 In an enzyme-catalysed reaction, which combination of inhibitor and substrate would result in the highest rate of reaction?

	inhibitor	substrate concentration
A	competitive	high
B	competitive	low
C	non-competitive	high
D	non-competitive	low

13 Following a heart attack, the enzyme lactate dehydrogenase leaks into the blood plasma from damaged heart muscle.

Which steps are required to obtain the best estimate of lactate dehydrogenase activity in a sample of blood plasma?

	sterilise blood plasma by heating	incubate with substrate for lactate dehydrogenase	incubate with lactate dehydrogenase inhibitor	
A	✓	✓	✓	key ✓ = step required x = step not required
B	x	✓	✓	
C	x	✓	x	
D	x	x	✓	

- 14 Red blood cells were placed in a solution of sodium chloride with a less negative water potential than the cell contents. Haemoglobin was released from the cells.

By what process was the haemoglobin released?

- A active transport
- B exocytosis
- C facilitated diffusion
- D lysis of cell

- 15 The table shows three processes that contribute to transport across cell surface membranes.

Which processes are the result of random movement of molecules?

	diffusion	facilitated diffusion	osmosis	
A	✓	✓	✗	key ✓ = random ✗ = non-random
B	✓	✓	✓	
C	✗	✓	✓	
D	✗	✗	✗	

- 16 The cell surface membranes of plants adapted to cold conditions change as the weather gets colder, allowing the plants to carry out exocytosis.

Which change occurs?

- A a decrease in the ratio of proteins to saturated phospholipids
- B a decrease in the ratio of unsaturated phospholipids to saturated phospholipids
- C an increase in the ratio of proteins to unsaturated phospholipids
- D an increase in the ratio of unsaturated phospholipids to saturated phospholipids

- 17 Which statements about a diploid cell are correct?

- 1 can divide by mitosis to repair itself
- 2 possesses two complete sets of chromosomes
- 3 undergoes a reduction division to form haploid cells
- 4 undergoes mitotic division to allow growth to occur

- A 1, 2, 3 and 4
- B 1, 2 and 3 only
- C 1, 2 and 4 only
- D 2, 3 and 4 only

18 Meiosis and mitosis are two types of cell division.

A cell has 20 chromosomes before it divides.

How many chromosomes will it have after dividing by meiosis or mitosis?

	meiosis	mitosis
A	5	20
B	10	20
C	20	10
D	40	10

19 The graph shows the length of the spindle fibres during mitosis.

Which region of the graph shows when the centromeres detach from the spindle fibres?

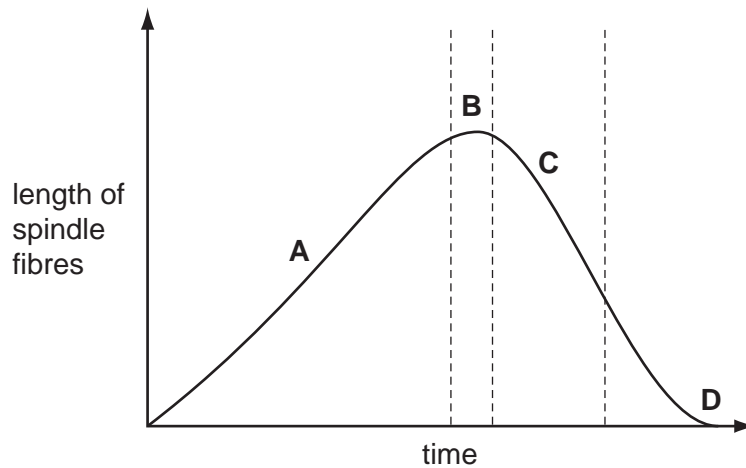

20 In a genetic engineering experiment, a piece of double-stranded DNA containing 12×10^3 nucleotides coding for specific polypeptide is transcribed and translated.

What is the total number of amino acids in this polypeptide?

- A** 6×10^3 **B** 4×10^3 **C** 2×10^3 **D** 1×10^3

21 What is the correct sequence for the processes involved in the formation of an enzyme in a cell?

- A** transcription → condensation → translation → ionic bonding
B translation → hydrogen bonding → transcription → condensation
C transcription → translation → condensation → ionic bonding
D translation → transcription → ionic bonding → hydrogen bonding

22 The diagram shows part of a DNA molecule.

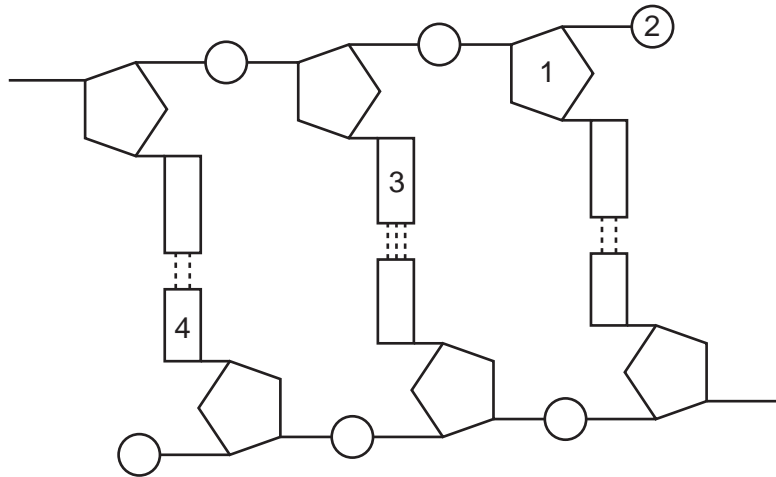

Which row correctly identifies the structures labelled 1, 2, 3 and 4?

	1	2	3	4
A	cytosine	phosphate	guanine	deoxyribose sugar
B	deoxyribose sugar	phosphate	adenine	cytosine
C	deoxyribose sugar	phosphate	cytosine	thymine
D	phosphate	deoxyribose sugar	cytosine	adenine

- 23 Bacteria were grown in a medium containing ^{15}N . After several generations, all of the DNA contained ^{15}N . Some of these bacteria were transferred to a medium containing the common isotope of nitrogen, ^{14}N . The bacteria were allowed to divide once. The DNA of some of these bacteria was extracted and analysed. This DNA was all hybrid DNA containing equal amounts of ^{14}N and ^{15}N .

Some bacteria from the medium with ^{15}N were transferred into a medium of ^{14}N . The bacteria were allowed to divide twice. The graph shows the percentages of ^{14}N and ^{15}N in the DNA of these bacteria.

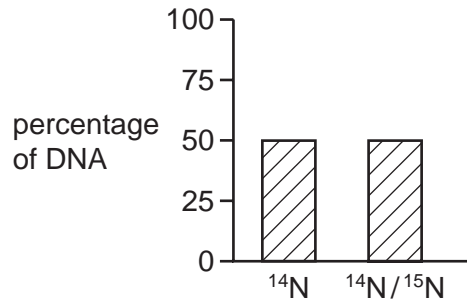

Some bacteria from the medium with ^{15}N were transferred into a medium of ^{14}N . The bacteria were allowed to divide three times.

What would be the percentages of ^{14}N and ^{15}N in the DNA extracted from these bacteria?

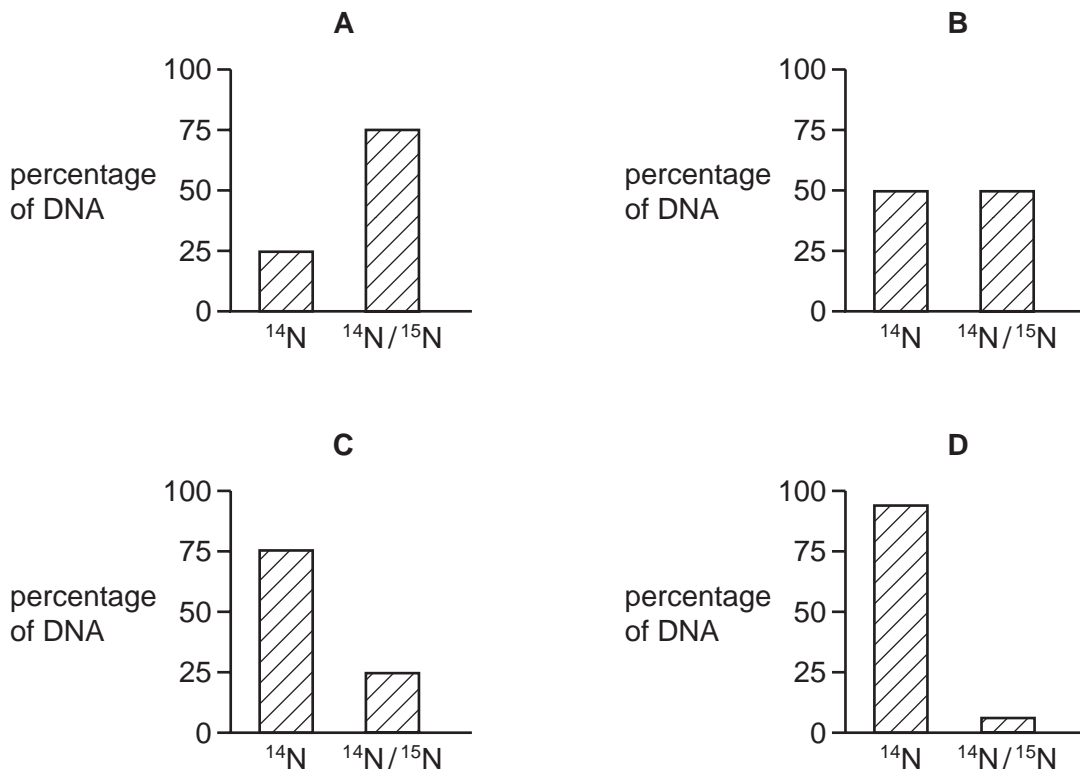

- 24 The diagram shows pressure changes in the aorta, left atrium and left ventricle during the cardiac cycle.

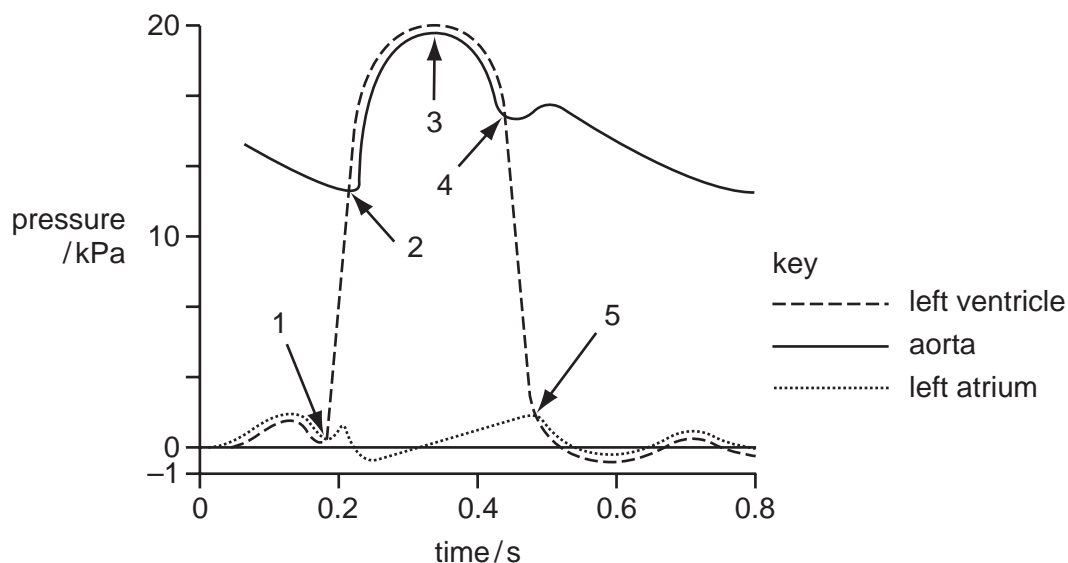

Which row explains the changes in the left ventricle at different times on the graph?

	region of graph	muscles of ventricle wall	volume of left ventricle
A	between 1 and 2	contract	remains constant
B	between 2 and 3	relax	increases
C	between 3 and 4	contract	remains constant
D	between 4 and 5	relax	decreases

- 25 Which row shows the changes in concentration in the red blood cells when carbon dioxide diffuses from respiring cells?

	carbonic anhydrase	hydrogencarbonate ions	hydrogen ions
A	decreases	no change	no change
B	increases	increases	increases
C	no change	decrease	increase
D	no change	increase	increase

26 The following are all structural components of blood vessels.

- 1 collagen fibres
- 2 elastic fibres
- 3 endothelial cells
- 4 smooth muscle cells

Which row shows the distribution of these components in different blood vessels?

	artery	vein
A	1, 2 and 4	1, 3 and 4
B	2, 3 and 4	1, 3 and 4
C	1, 2, 3 and 4	1, 2, 3 and 4
D	1, 2, 3 and 4	2, 3 and 4

27 Which components of blood are also present in tissue fluid?

	phagocytes	proteins	sodium ions
A	x	✓	x
B	✓	✓	✓
C	✓	x	✓
D	x	✓	✓

key

✓ = present

x = absent

28 The diagram shows a longitudinal section through transport tissue in a plant stem.

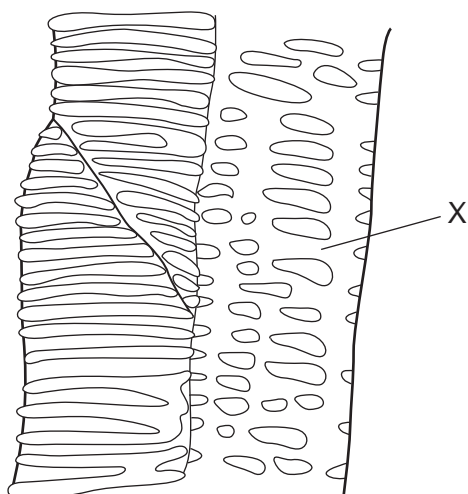

What are the names of the element labelled X and the tissue in which it is found?

	element X	tissue
A	sieve tube	phloem
B	sieve tube	xylem
C	vessel	phloem
D	vessel	xylem

29 The diagram shows the tissues of the transport system of flowering plants.

Where is the water potential **most** negative?

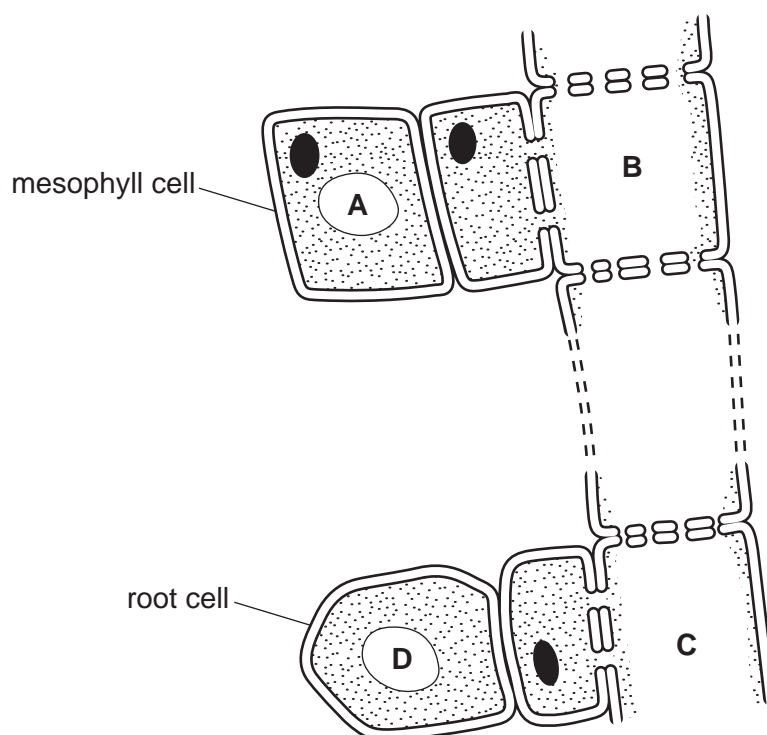

30 Which evidence supports the theory of water movement by root pressure in flowering plants?

- 1 When the rate of transpiration of a tree is maximum, the diameter of the trunk is minimum.
- 2 When a plant shoot is removed close to the base of the stem, sap leaks out from the cut.
- 3 Evaporation of water from a porous pot can exert a force that draws water up a glass tube attached underneath the pot.
- 4 Droplets of water form at the edge of leaves of plants growing in conditions of soil with high water content and air with high humidity.

A 1 and 2 **B** 1 and 3 **C** 2 and 3 **D** 2 and 4

31 Cardiovascular disease is said to be multifactorial.

What does this mean?

- A** You can get the disease, if you are exposed to one or more risk factors.
- B** You can never get the disease, if you are exposed to only one risk factor.
- C** You only get the disease, if you are exposed to all the risk factors.
- D** You will always get the disease, if you are exposed to all the risk factors.

- 32 The first diagram shows a spirometer, which is an apparatus used to measure changes in lung volume. The cover rises during exhalation and falls during inhalation, producing a trace on the rotating drum. The second diagram shows a typical trace from a spirometer.

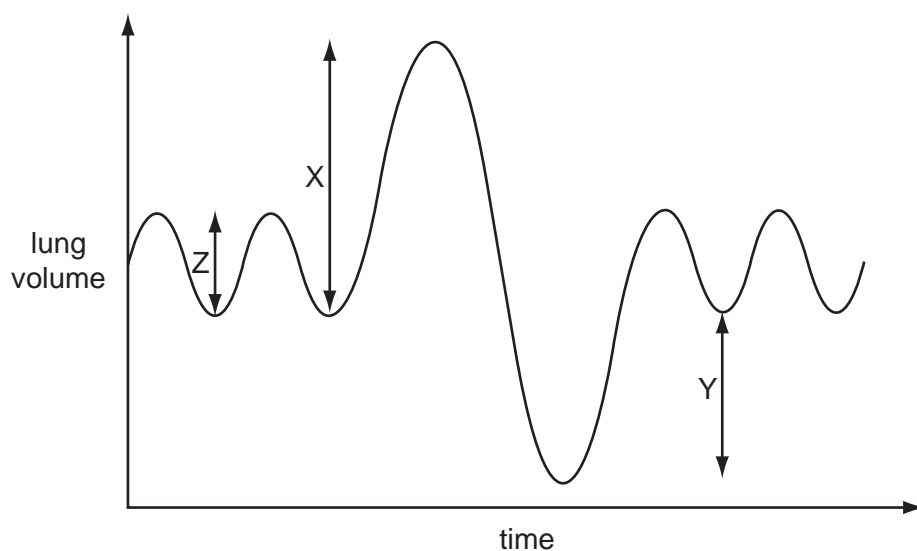
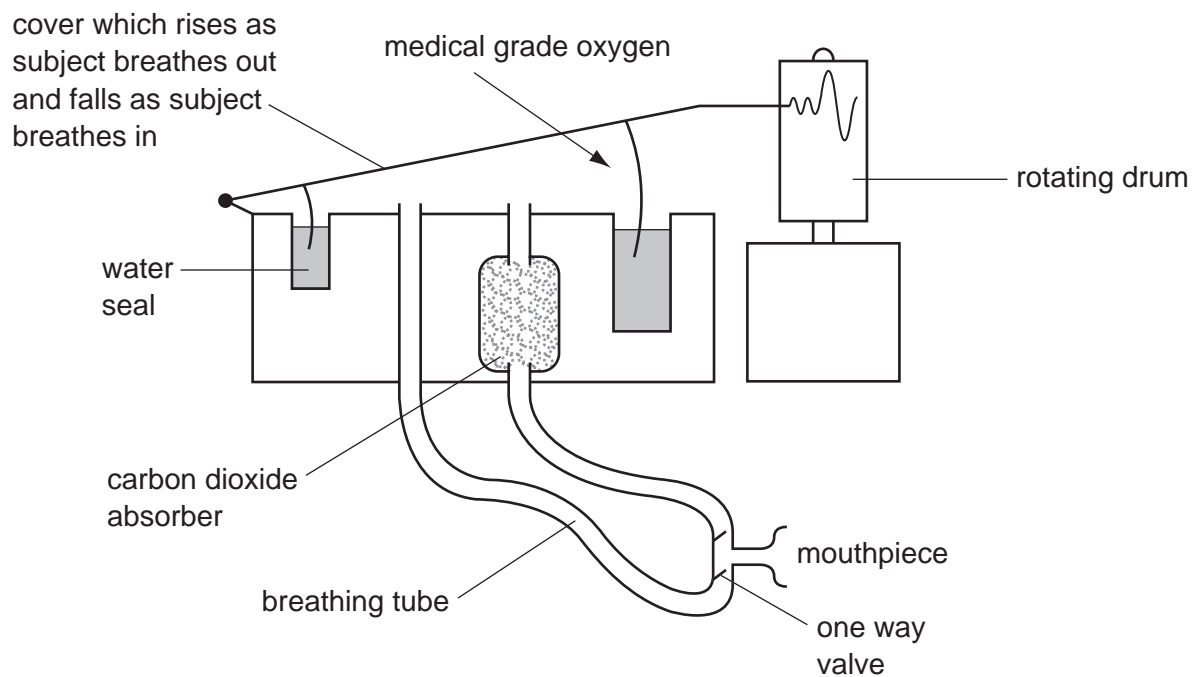

Which would give the vital capacity?

- A** $X + Y$ **B** $X - Y$ **C** $X + Y + Z$ **D** $X - Y + Z$

- 33 Which row shows a correct location of cartilage and smooth muscle in the human gas exchange system?

	cartilage	smooth muscle
A	respiratory bronchioles	terminal bronchioles
B	respiratory bronchioles	trachea
C	trachea	bronchi
D	trachea	respiratory bronchioles

- 34 Which observation would indicate a difference between the structure of the gas exchange system of a cigarette smoker and a non-smoker?

- A** the absence of ciliated epithelium in the bronchioles
- B** the decrease in elastic fibres in the bronchioles
- C** the enlargement of goblet cells in the bronchi
- D** the increase in smooth muscle

- 35 Which row is correct?

	disease	causative agent	method of infection
A	cholera	bacterium	ingestion
B	HIV/AIDS	virus	water-borne
C	malaria	protoctist	blood transfusion
D	tuberculosis (TB)	virus	inhalation

- 36 Why is passive immunity effective for only a short time?

- A** antibodies are rapidly broken down
- B** antigens are rapidly broken down
- C** memory cells soon die
- D** phagocytes soon die

- 37 What is the first response by the immune system to a pathogen?

- A** ingestion of the pathogen by B-lymphocytes
- B** ingestion of the pathogen by phagocytes
- C** production of antibodies
- D** production of antigens

38 Within an ecosystem, the top consumers in a food chain are few in number.

Which statement explains this?

- A Energy losses in the consumers' digestive systems.
- B Energy losses occur at each trophic level.
- C Top consumers have a low reproductive rate.
- D Top consumers are large in size.

39 The diagram shows the flow of energy through a food chain. Figures are in $\text{kJ m}^{-2} \text{ year}^{-1}$.

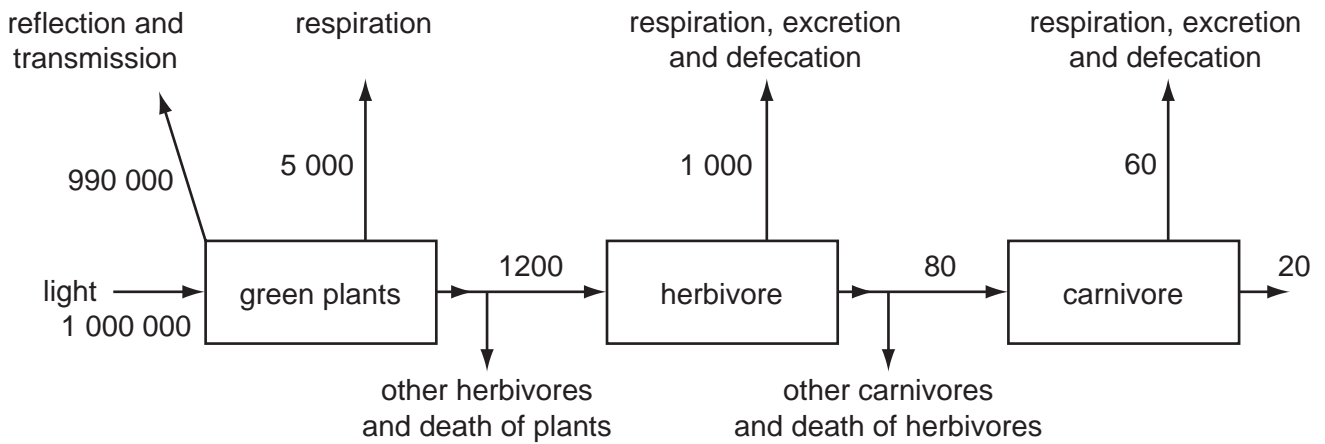

What percentage of light energy is converted to net primary productivity?

- A 0.1%
- B 0.5%
- C 1.0%
- D 5.0%

40 The diagram shows part of the nitrogen cycle.

Which process is increased in poorly drained soil?

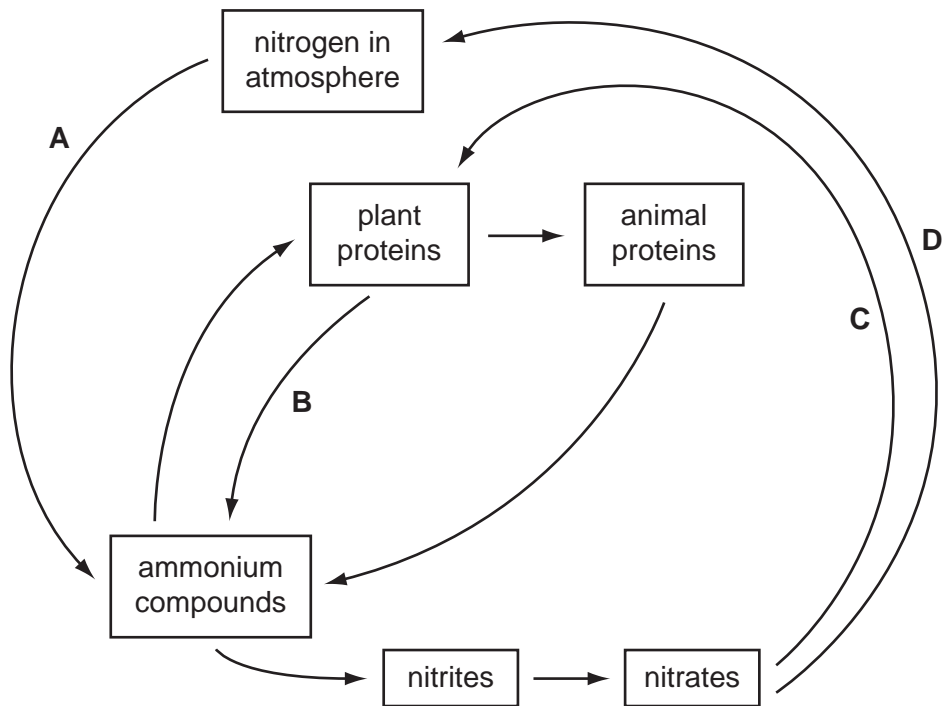

BLANK PAGE

Permission to reproduce items where third-party owned material protected by copyright is included has been sought and cleared where possible. Every reasonable effort has been made by the publisher (UCLES) to trace copyright holders, but if any items requiring clearance have unwittingly been included, the publisher will be pleased to make amends at the earliest possible opportunity.

University of Cambridge International Examinations is part of the Cambridge Assessment Group. Cambridge Assessment is the brand name of University of Cambridge Local Examinations Syndicate (UCLES), which is itself a department of the University of Cambridge.