

UNIVERSITY OF CAMBRIDGE INTERNATIONAL EXAMINATIONS
General Certificate of Education
Advanced Subsidiary Level and Advanced Level

BIOLOGY

9700/01

Paper 1 Multiple Choice

May/June 2006

1 hour

Additional Materials: Multiple Choice Answer Sheet
Soft clean eraser
Soft pencil (type B or HB is recommended)

READ THESE INSTRUCTIONS FIRST

Write in soft pencil.

Do not use staples, paper clips, highlighters, glue or correction fluid.

Write your name, Centre number and candidate number on the Answer Sheet in the spaces provided unless this has been done for you.

There are **forty** questions on this paper. Answer **all** questions. For each question there are four possible answers **A, B, C** and **D**.

Choose the **one** you consider correct and record your choice in **soft pencil** on the separate Answer Sheet.

Read the instructions on the Answer Sheet very carefully.

Each correct answer will score one mark. A mark will not be deducted for a wrong answer.
Any rough working should be done in this booklet.

This document consists of **16** printed pages.



1 What is the resolution, in nanometres, of an electron microscope and of a light microscope?

	electron microscope	light microscope
A	0.5	20
B	0.5	200
C	5.0	20
D	5.0	200

2 The diagram shows a drawing of an electron micrograph of a cell.

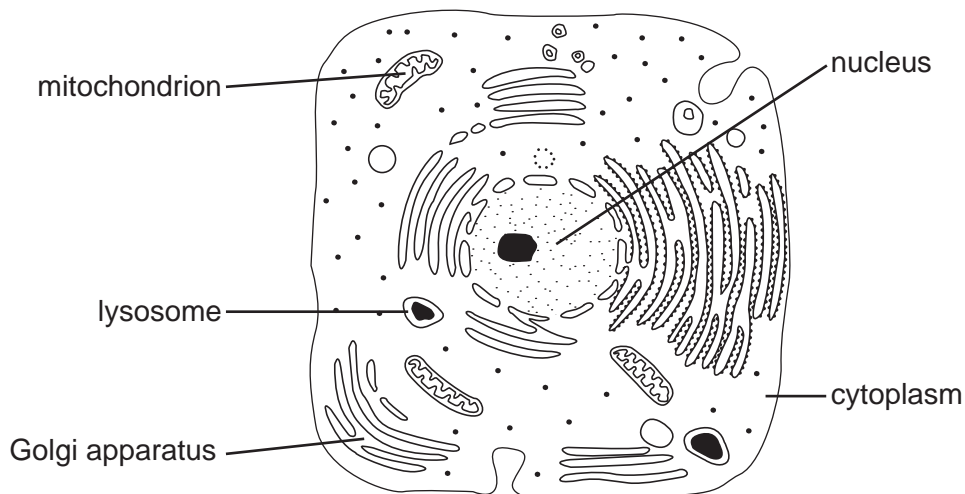

Which structures are surrounded by double membranes?

	Golgi apparatus	lysosome	mitochondrion	nucleus	cytoplasm
A	✓	✓	✓	✓	✓
B	✓	x	x	x	x
C	x	x	✓	✓	x
D	x	✓	x	x	✓

3 In which animal cells would Golgi apparatus be most abundant?

- A** ciliated epithelial cells
- B** goblet cells
- C** red blood cells
- D** smooth muscle cells

- 4 Which adaptation would increase the efficiency of active transport of carbohydrates from a plant cell?
- A areas where the cell wall is thin
 - B increased permeability of the cell wall
 - C large surface area of the cell surface membrane
 - D selective permeability of the vacuole membrane
- 5 Which is a feature of all prokaryotic cells?
- A absence of cell surface membrane
 - B division by mitosis
 - C presence of mitochondria
 - D presence of ribosomes
- 6 The diagram shows a cell surface membrane. The lipid bilayer has an approximate width of 8 nm.

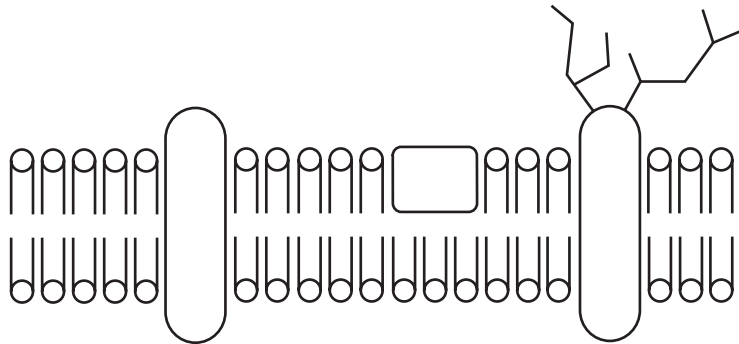

How many times has the diagram been magnified?

- A 2.5×10^2
 - B 2.5×10^4
 - C 2.5×10^6
 - D 2.5×10^8
- 7 Which type of reaction takes place when starch molecules are converted into reducing sugars?
- A condensation
 - B hydrolysis
 - C polymerisation
 - D synthesis

- 8 A solution of starch is mixed with a solution of amylase.

Which reagent should be used to confirm that a reaction had taken place and what would be the appearance of the mixture when the reaction was complete?

	reagent	the appearance of the mixture
A	Benedict's solution	brick-red
B	biuret solution	blue
C	ethanol	cloudy
D	iodine in potassium iodide solution	blue-black

- 9 The diagrams show different types of bond found in polysaccharides.

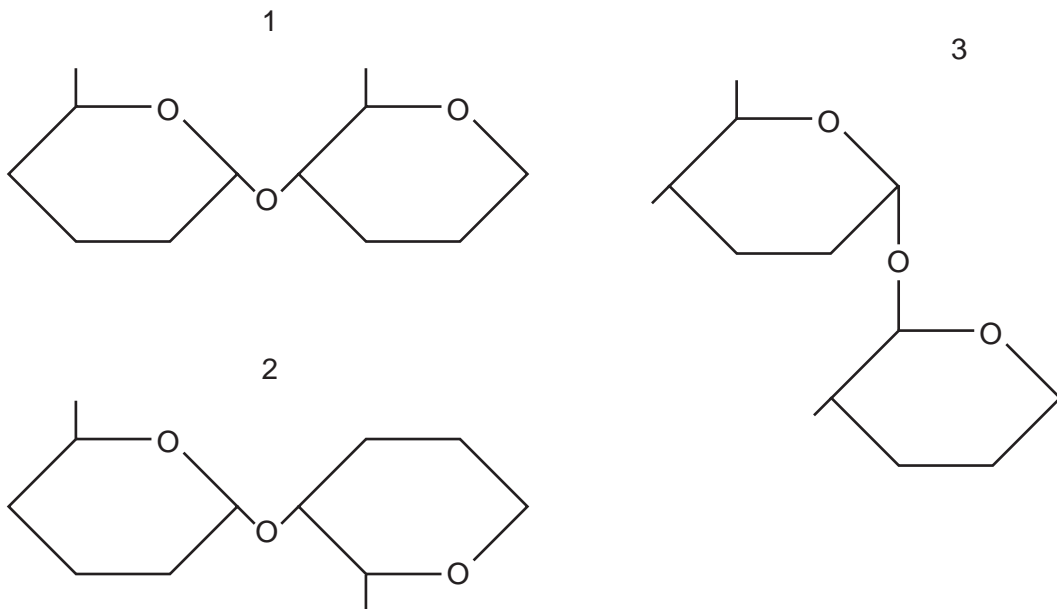

Which type or types of bond are found in amylose?

- A** 1 only
B 2 only
C 1 and 3 only
D 2 and 3 only
- 10 At which levels of protein structure do hydrophobic interactions occur?
- A** primary, secondary and tertiary
B primary, secondary, tertiary and quaternary
C tertiary and quaternary
D quaternary only

11 The diagram shows a dipeptide.

Which bond is the peptide bond?

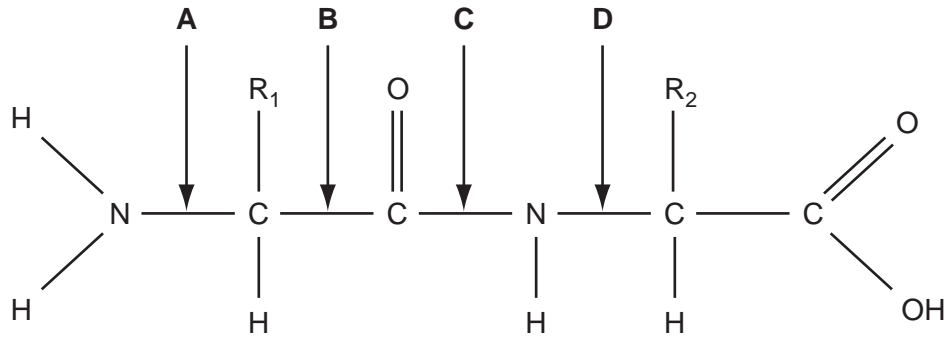

12 The movement of water through the vascular tissue in plants relies on which property of water?

- A changes in density with temperature
- B good solvent for ions and polar molecules
- C high specific heat capacity
- D strong cohesive forces between molecules

- 13 Two enzyme experiments were carried out. The first, experiment **X**, was carried out at a constant temperature of 37°C. During the second experiment the temperature was increased from 37°C to 80°C.

Which graph shows the results?

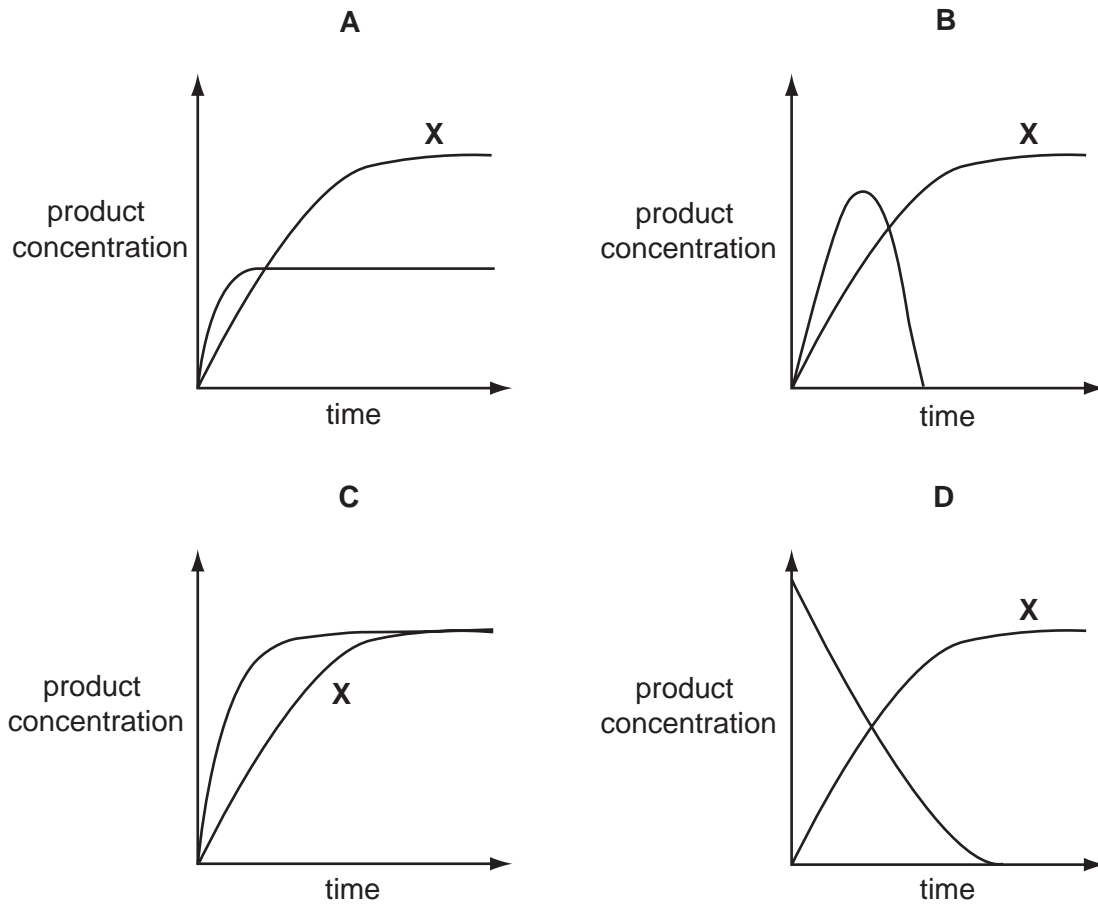

- 14 Which properties are characteristic of a non-competitive inhibitor of an enzyme?

	binding	effect of adding more substrate
A	at active site	reduces inhibition
B	at active site	does not reduce inhibition
C	not at active site	reduces inhibition
D	not at active site	does not reduce inhibition

- 15 Which statement defines active transport?
- A movement of large molecules through the cell surface membrane into the cytoplasm of a cell
 - B movement of molecules or ions from where they are in a low concentration to where they are in a higher concentration
 - C movement of molecules or ions from where they are in a high concentration to where they are in a lower concentration
 - D net movement of water molecules across a partially permeable membrane from a region of higher water potential to one of lower water potential
- 16 Which pair of factors is inversely proportional to the rate of diffusion?
- A concentration gradient and size of diffusing molecule
 - B distance over which diffusion occurs and surface area over which diffusion occurs
 - C size of diffusing molecule and distance over which diffusion occurs
 - D surface area over which diffusion occurs and concentration gradient
- 17 When cylinders of potato tissue were immersed in a 0.35 mol dm^{-3} sucrose solution, they showed no change in mass.
- What will happen when cylinders are immersed in a 0.1 mol dm^{-3} sucrose solution?
- A The pressure potential of the cells will become more positive.
 - B The solute potential of the cell will become more negative.
 - C The water potential of the cells will become more negative.
 - D The water potential of the solution will become less negative.
- 18 Which cell activity must occur before prophase of mitosis can begin?
- A breakdown of the nuclear envelope
 - B increased production of mRNA
 - C migration of centrioles to opposite poles
 - D replication of DNA

19 What are the conditions in a human cell just before the cell enters prophase?

	number of chromatids	number of molecules of DNA in nucleus	spindle present	nuclear envelope present
A	46	46	yes	no
B	92	46	no	yes
C	46	92	yes	yes
D	92	92	no	yes

20 The diagram shows the mitotic cell cycle.

When radioactive nucleotides are supplied to dividing cells, at which point will they be incorporated into the chromosomes?

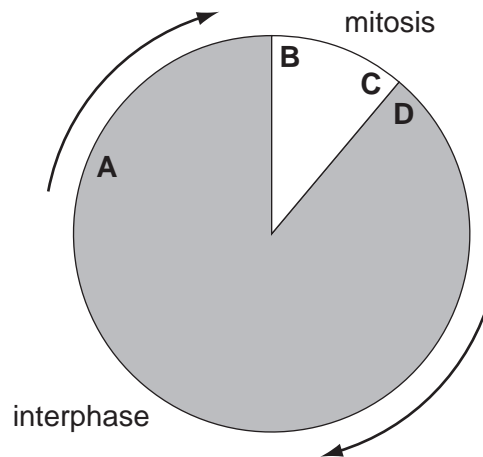

21 The diagram shows part of a DNA molecule.

Which part is a nucleotide?

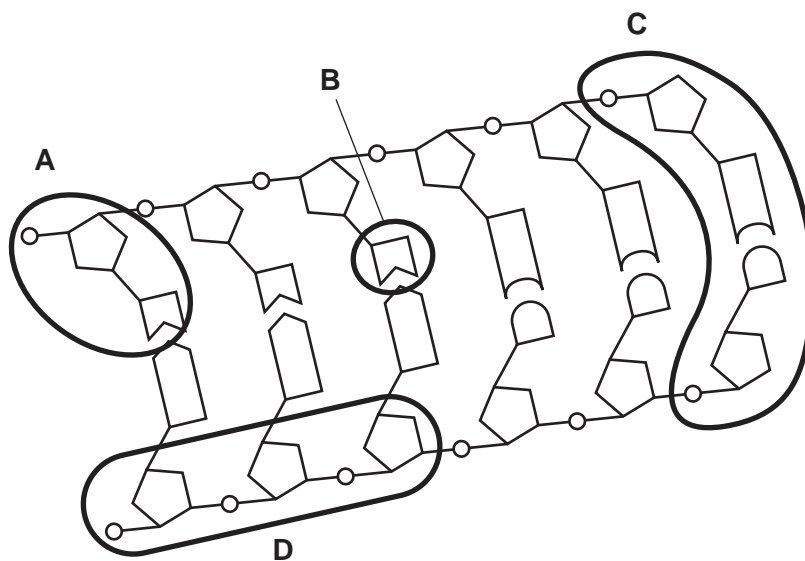

- 22 Bacteria were grown for many generations in a medium containing a heavy isotope of nitrogen, ^{15}N . They were then transferred to a medium containing the light isotope of nitrogen, ^{14}N . They were given time to replicate DNA and divide once. Their DNA was extracted, spun in a centrifuge and observed using ultra violet light. The DNA with the ^{15}N settled at a lower depth than the DNA with the ^{14}N .

Which shows the predicted results after one generation in the medium with the light isotope?

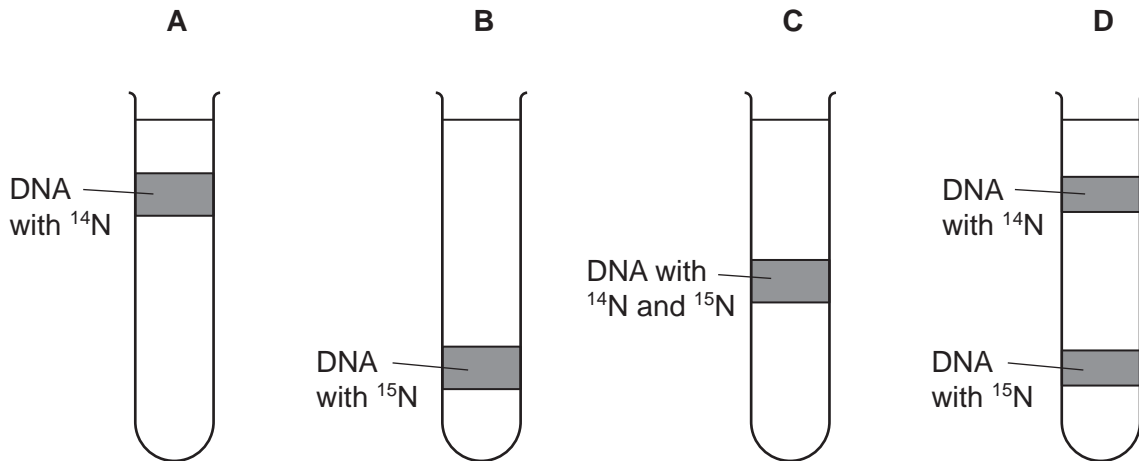

- 23 In a genetic engineering experiment a piece of double-stranded DNA containing 6000 nucleotides is transcribed and translated.

What is the total number of amino acids used?

- A 500 B 1000 C 2000 D 3000
- 24 DNA from a chromosome is analysed and 20% of its bases are found to be cytosine.

Which percentage of uracil molecules will be found in mRNA transcribed from this DNA?

- A 20 B 30 C 40 D 60

- 25 The graph shows the relationship between the loss of water vapour through stomata and an environmental factor.

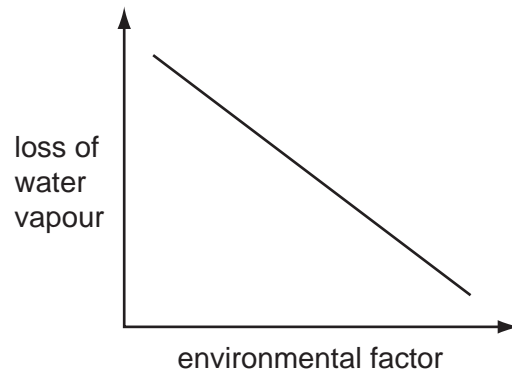

What is the environmental factor?

- A air temperature
 - B atmospheric humidity
 - C light intensity
 - D wind velocity
- 26 The diagram shows a longitudinal section through transport tissue in a plant stem.

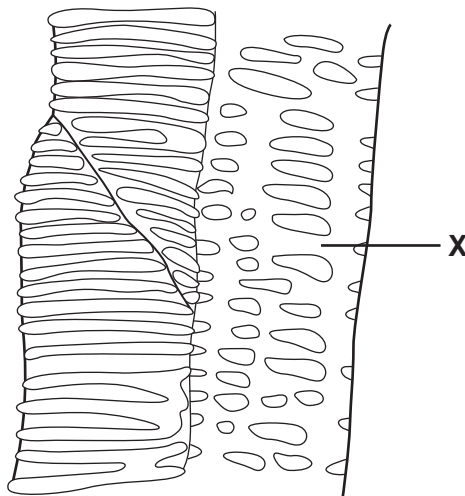

What are the names of the structure labelled X and the tissue in which it is found?

	structure X	tissue
A	sieve tube	phloem
B	sieve tube	xylem
C	vessel	phloem
D	vessel	xylem

27 What is responsible for the movement of water up xylem vessels in plants?

- A active loading of water against the water potential gradient in the roots and osmosis in the vessels
- B increasing water potential at the top of xylem vessels, and osmosis in the roots
- C decreasing water potential at the top of the xylem vessels, with cohesion of water in the vessels
- D translocation in the leaves, with capillarity in the xylem vessels

28 What does tissue fluid contain?

	phagocytes	platelets	protein concentration compared to blood plasma
A	✓	✓	higher
B	x	x	higher
C	✓	x	lower
D	x	✓	lower

29 The diagram shows the Bohr Effect.

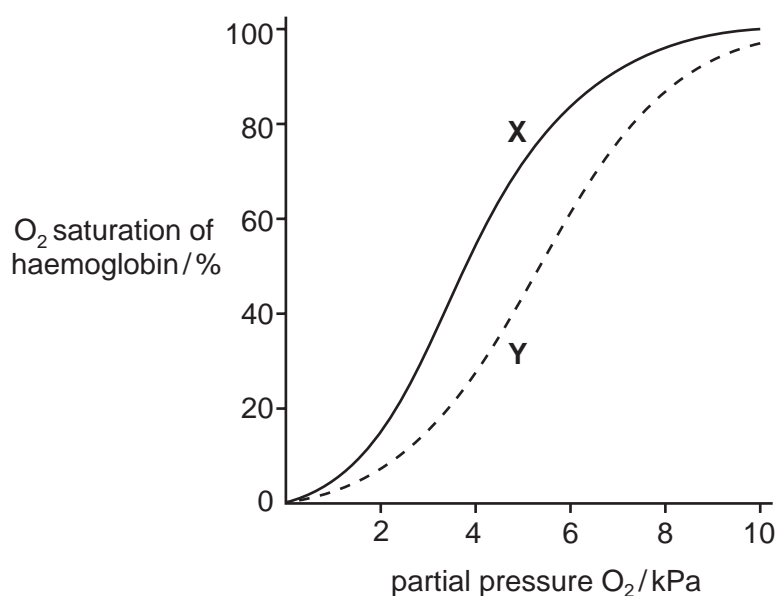

What causes the shift from X to Y?

- A decreased levels of carbon dioxide and high pH
- B decreased levels of carbon dioxide and low pH
- C increased levels of carbon dioxide and high pH
- D increased levels of carbon dioxide and low pH

- 30 The diagram shows pressure changes in the left side of the heart and aorta over time. The length of this cardiac cycle is 0.6 s. Points 1, 2, 3 and 4 indicate when atrio-ventricular valves and semi-lunar valves either open or close.

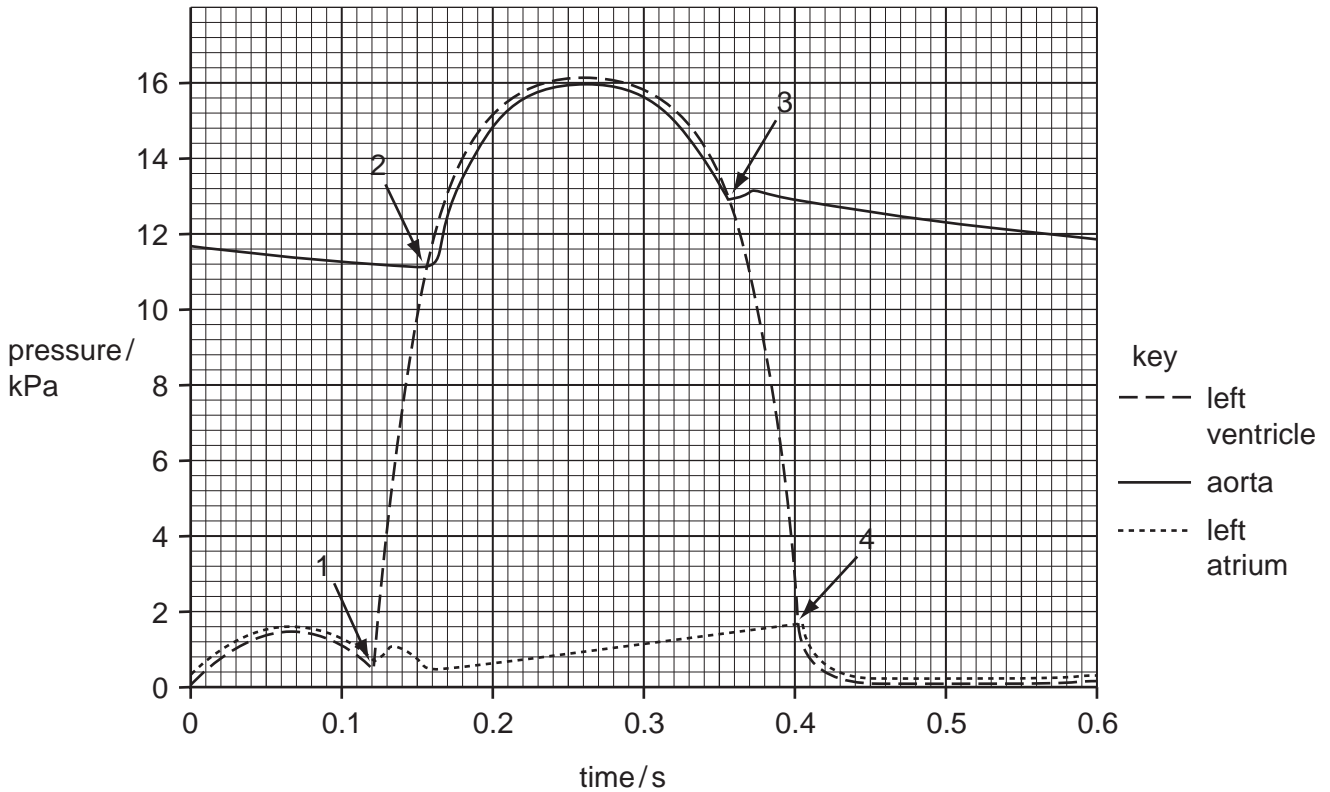

What is the total time during one cardiac cycle that the atrio-ventricular valves and the semi-lunar valves are both closed at the same time?

- A 0.03 s B 0.04 s C 0.07 s D 0.21 s
- 31 Which correctly shows the areas of the respiratory tract that contain cartilage, goblet cells, smooth muscle and cilia (ciliated epithelium)?

	cartilage	goblet cells	smooth muscle	cilia
A	bronchus bronchiole	alveoli bronchiole	bronchus alveoli	bronchus bronchiole
B	trachea bronchus	bronchiole alveoli	bronchus bronchiole	trachea bronchus
C	trachea bronchiole	trachea bronchus	trachea alveoli	bronchiole alveoli
D	trachea bronchus	trachea bronchus	bronchus bronchiole	trachea bronchiole

32 The diagram shows stages in the development of the disease emphysema.

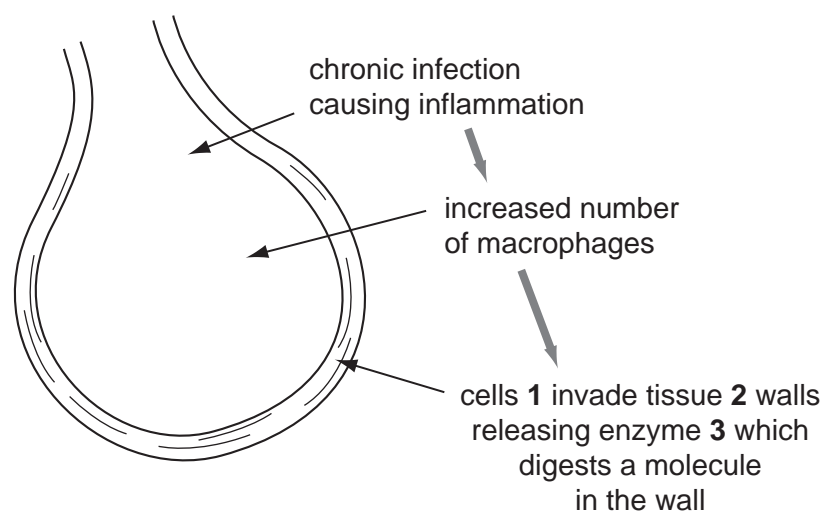

What is correct for 1, 2 and 3?

	1	2	3
A	lymphocytes	alveoli	elastase
B	lymphocytes	bronchiole	ligase
C	phagocytes	alveoli	elastase
D	phagocytes	bronchiole	ligase

33 The photomicrographs show an artery from a non-smoker and a smoker.

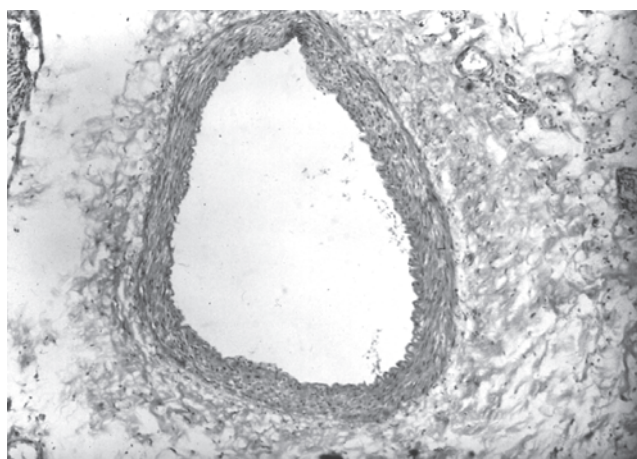

non-smoker

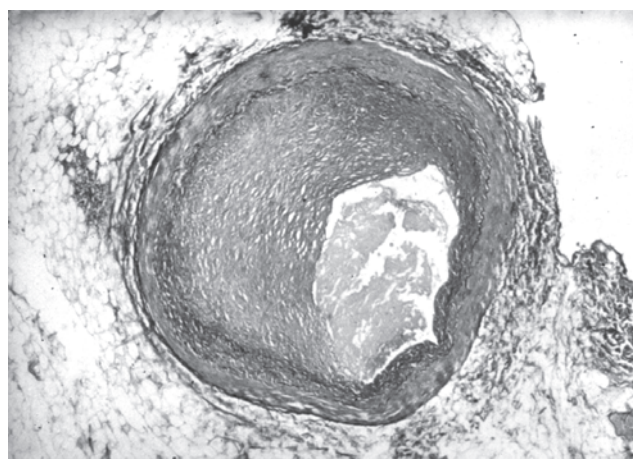

smoker

What is the reason that the smoker's artery looks like this?

- A A cancerous tumour has formed and is blocking the lumen.
- B Nicotine has damaged the artery endothelium causing a plaque.
- C Tar has stuck to the artery wall forming a blockage.
- D The artery has become constricted due to carbon monoxide.

34 What do the causative agents of HIV/AIDS, malaria and TB have in common?

	they have a cell surface membrane	they have genes	they have ribosomes	they respire
A	✓	✓	✓	✓
B	✓	x	x	✓
C	x	✓	x	✓
D	x	✓	x	x

35 The antibiotic streptomycin is now proving to be less effective in reducing the incidence of tuberculosis (TB) worldwide.

What is the reason for this observation?

- A** Antibiotics such as streptomycin are not effective as antiviral drugs.
- B** Fewer people are living in isolated rural areas and overcrowding occurs in inner cities.
- C** The incidence of HIV infection is increasing, activating previously inactive *Mycobacterium*.
- D** There is an increase in the number of people infected with drug resistant strains.

36 The diagram shows part of the immune response.

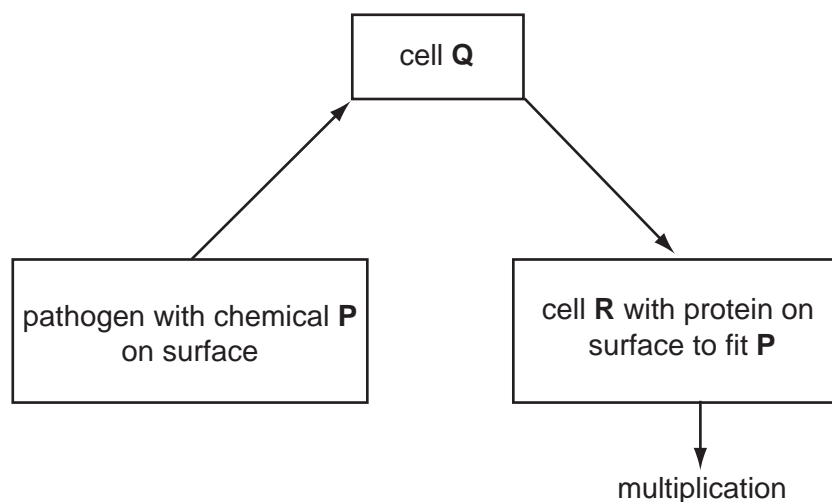

What are **P**, **Q** and **R**?

	P	Q	R
A	antibody	phagocyte	T helper cell
B	antigen	T helper cell	B-lymphocyte
C	antibody	T helper cell	phagocyte
D	antigen	B-lymphocyte	T helper cell

37 New-born babies have natural passive immunity.

Why is this only temporary?

- A No memory cells are produced in the baby.
- B The antibodies are insufficient in number.
- C The antibodies only act in the mother.
- D The immunity is not inherited.

38 A tree carries out photosynthesis and provides organic compounds for other organisms in a forest. It takes carbon dioxide from and returns oxygen to the atmosphere. It takes water from the soil into its roots and its leaves lose water to the atmosphere. Many other organisms live in the tree.

Which of these terms applies to the description of the tree?

- A community
- B ecosystem
- C habitat
- D niche

39 Which box contains only the parts of an ecosystem which are classed as a food web?

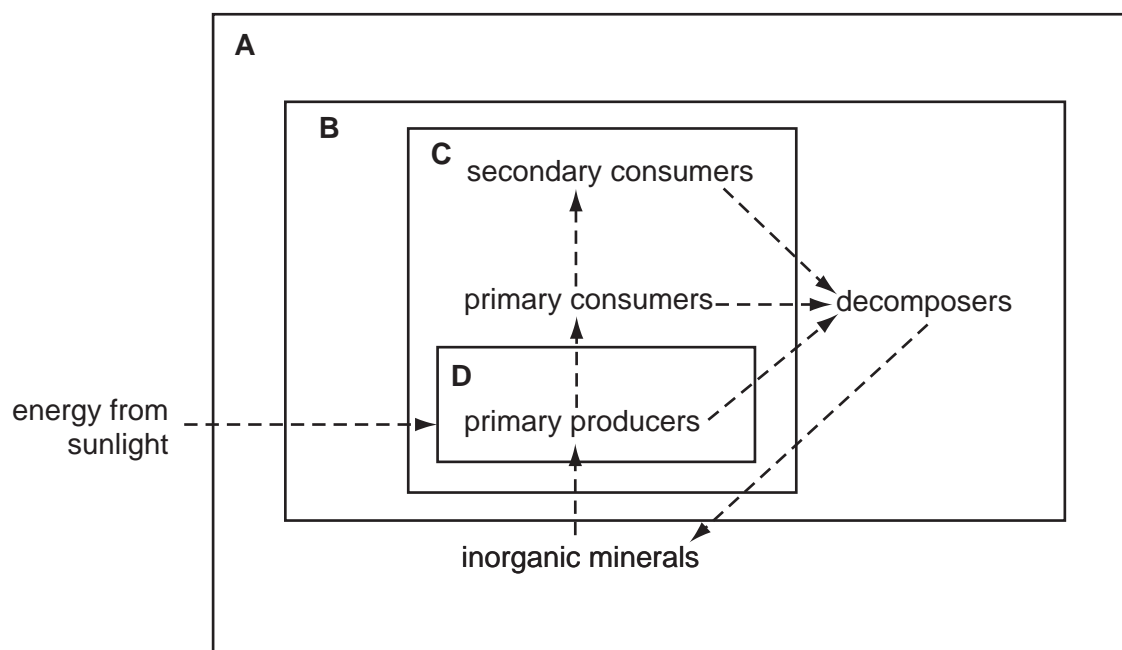

40 Which process does **not** make nitrogen-containing compounds available to plants?

- A ammonification by decomposers
- B denitrification by denitrifying bacteria
- C nitrogen fixation in plant root nodules
- D nitrogen fixation by soil bacteria

Permission to reproduce items where third-party owned material protected by copyright is included has been sought and cleared where possible. Every reasonable effort has been made by the publisher (UCLES) to trace copyright holders, but if any items requiring clearance have unwittingly been included, the publisher will be pleased to make amends at the earliest possible opportunity.

University of Cambridge International Examinations is part of the University of Cambridge Local Examinations Syndicate (UCLES), which is itself a department of the University of Cambridge.