

CANDIDATE
NAME

| |
|--|
| |
|--|

CENTRE
NUMBER

| | | | | |
|--|--|--|--|--|
| | | | | |
|--|--|--|--|--|

CANDIDATE
NUMBER

| | | | |
|--|--|--|--|
| | | | |
|--|--|--|--|



PHYSICS

0625/23

Paper 2 Core

October/November 2015

1 hour 15 minutes

Candidates answer on the Question Paper.

No Additional Materials are required.

READ THESE INSTRUCTIONS FIRST

Write your Centre number, candidate number and name on all the work you hand in.

Write in dark blue or black pen.

You may use an HB pencil for any diagrams or graphs.

Do not use staples, paper clips, glue or correction fluid.

DO NOT WRITE IN ANY BARCODES.

Answer **all** questions.

Electronic calculators may be used.

You may lose marks if you do not show your working or if you do not use appropriate units.

Take the weight of 1 kg to be 10 N (i.e. acceleration of free fall = 10 m/s^2).

At the end of the examination, fasten all your work securely together.

The number of marks is given in brackets [] at the end of each question or part question.

The syllabus is approved for use in England, Wales and Northern Ireland as a Cambridge International Level 1/Level 2 Certificate.

This document consists of **21** printed pages and **3** blank pages.

- 1 A student investigates the density of three different liquids.

The student pours liquid honey into a container, as shown in Fig. 1.1.

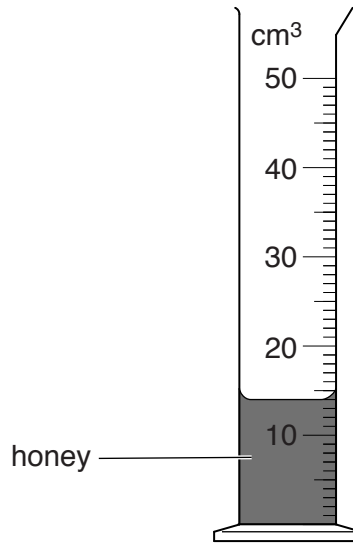

Fig. 1.1

- (a) (i) Name the container shown in Fig. 1.1.

..... [1]

- (ii) Name the other piece of apparatus necessary when determining the density of the honey.

..... [1]

- (b) The student then carefully adds some water and then some kerosene. The liquids do not mix but form three separate layers as shown in Fig. 1.2.

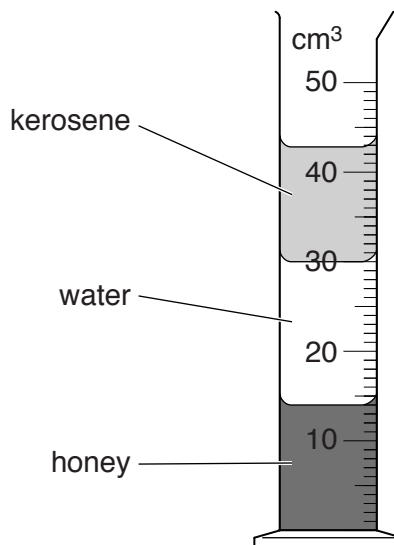

Fig. 1.2

Identify the correct statements about the densities of the liquids. Tick only **two** boxes.

- Honey has the smallest density.
- Honey has a larger density than water.
- Kerosene has the largest density.
- Kerosene has a smaller density than water.
- Water has a larger density than honey.
- Water has a smaller density than kerosene.

[2]

- (c) The mass of 13 cm^3 of the kerosene is 10.5g.

Calculate the density of the kerosene, including an appropriate unit.

density = [4]

[Total: 8]

- 2 Cameras are used to check average speeds on a long straight road. Each camera records the exact time that a car passes the camera.

Fig. 2.1 shows three cameras and the times at which the car passes.

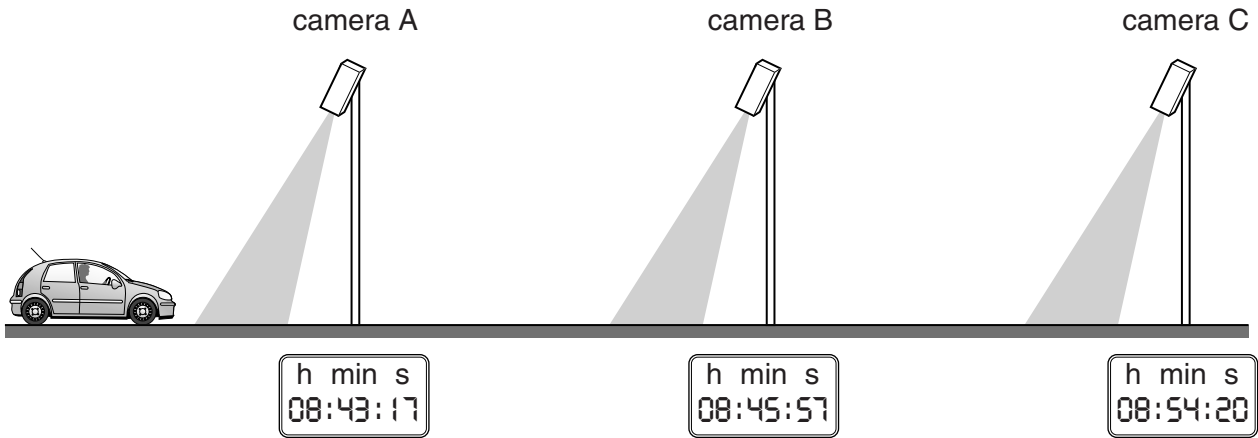

Fig. 2.1 (not to scale)

- (a) (i) Calculate the time taken for the car to travel between camera A and camera B. State your answer in seconds.

time taken = s [2]

- (ii) The cameras are placed 5000 m apart.

Calculate the average speed of the car between camera A and camera B.

average speed = m/s [3]

(iii) Using the information on the clocks, describe the average speed of the car between camera B and camera C. Tick **one** box.

- slightly slower than between A and B
- much slower than between A and B
- same as between A and B
- slightly faster than between A and B
- much faster than between A and B

[1]

(b) The speed limit for the road is 30 m/s.

Use your answers to (a)(ii) and (a)(iii) to estimate whether the car's average speed was greater or less than the speed limit when travelling between camera A and camera C. Explain how you decided on your answer.

estimate

explanation

.....

.....

[3]

[Total: 9]

3 (a) There are three states of matter.

Draw three lines, each line connecting a state of matter to the diagram representing the arrangement of the particles in that state of matter.

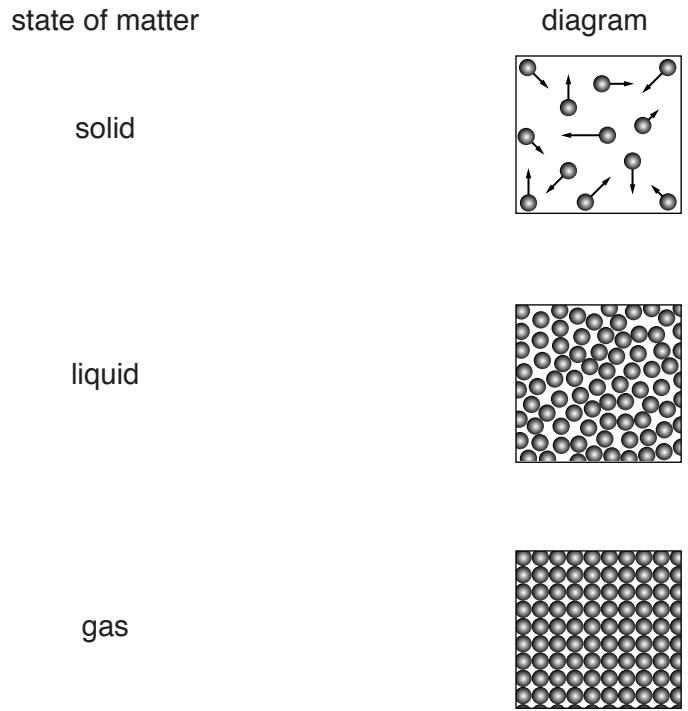

[1]

(b) Fig. 3.1 shows a perfume bottle.

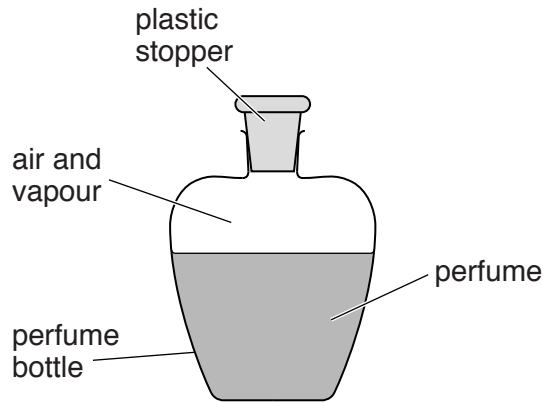

Fig. 3.1

(i) A student pours a small amount of perfume onto her arm. She notices that her arm feels cold as the perfume evaporates.

Explain why the evaporating perfume produces a cooling effect on her arm.

.....

.....

..... [2]

- (ii) When the perfume bottle is left by a window on a hot day, the stopper pops out of the bottle.

Suggest why the stopper pops out of the bottle.

.....
.....
.....
..... [3]

[Total: 6]

4 A student has a mobile (cell) phone. The phone receives a signal from a transmitter and produces a ring tone.

(a) State two differences between the microwave signal received by the phone and the sound wave produced when the phone rings.

1.

2.

[2]

(b) Fig. 4.1 represents the waves emitted by the mobile phone. The waves interact with a wall, and a doorway, in the room.

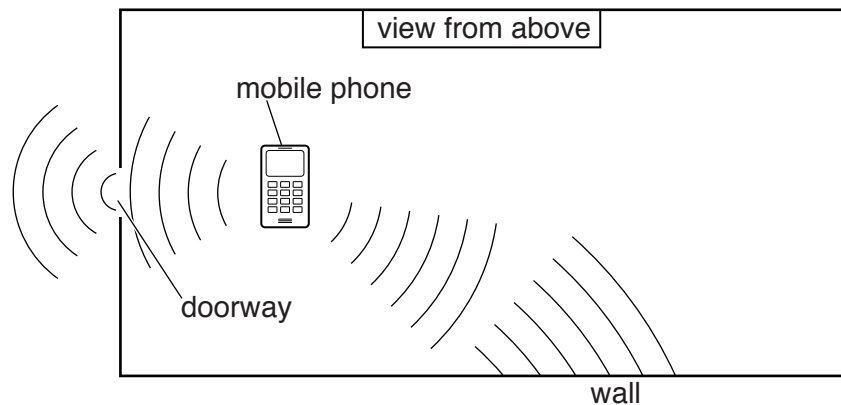

Fig. 4.1 (not to scale)

With reference to Fig. 4.1, complete each of the following sentences using a word from the box below.

| | | | |
|------------|-----------|-----------|-----------|
| diffracted | dispersed | reflected | refracted |
|------------|-----------|-----------|-----------|

(i) When the waves hit the wall, the waves are [1]

(ii) When the waves pass through the doorway, the waves are [1]

[Total: 4]

5 Fig. 5.1 shows a simple liquid-in-glass (alcohol) thermometer made by a technician in a laboratory.



Fig. 5.1

The thermometer is to be used to measure temperatures in the range -10°C to 110°C . There is no scale on the thermometer.

(a) The scale is added using fixed points.

State the temperature of each of the fixed points used.

upper fixed point = $^{\circ}\text{C}$

lower fixed point = $^{\circ}\text{C}$

[2]

(b) Describe how the thermometer is cooled to its lower fixed point.

.....

.....

.....

..... [2]

(c) Identify the physical property used by a liquid-in-glass thermometer to measure temperature. Tick **one** box.

- colour
- expansion
- pressure
- resistance

[1]

[Total: 5]

6 Fig. 6.1 shows a sign used to warn drivers of a road hazard.

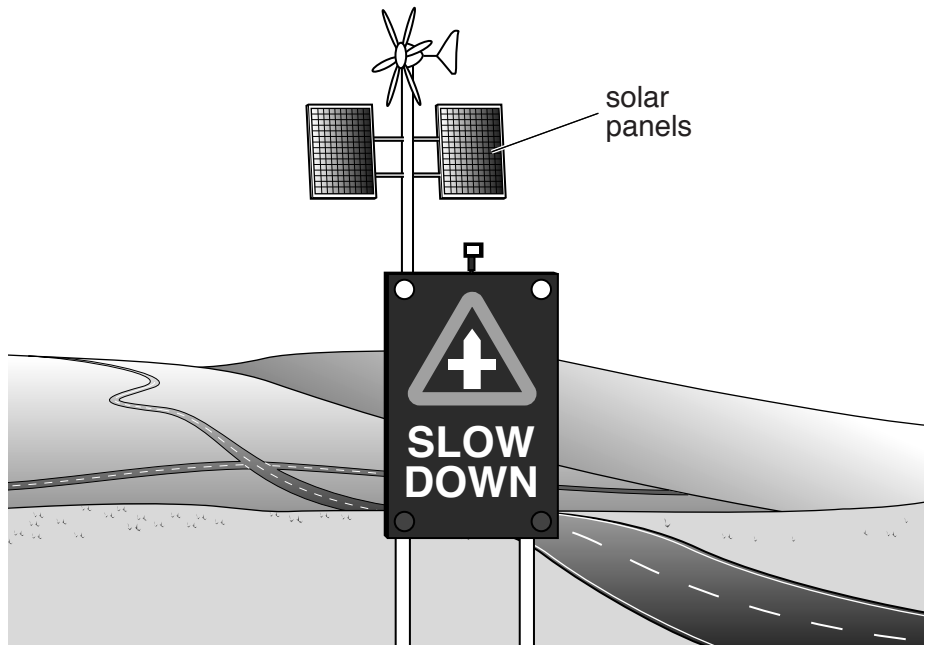

Fig. 6.1

The sign lights up as cars approach.

(a) The sign makes use of two sources of renewable energy, one of which is solar energy.

Identify the other source of renewable energy used by the sign. Tick the correct box.

- chemical
- geothermal
- light
- wind

[1]

(b) Fill in the blank spaces to complete one of the useful energy conversions taking place when the sign is operating using solar energy.

solar energy → →

[2]

(c) (i) In certain conditions, the sign cannot use its sources of renewable energy.

State these conditions.

..... [2]

(ii) The sign needs to be able to operate at all times.

Suggest a way of overcoming the problem identified in **(c)(i)**.

..... [1]

(d) After passing the sign, the cars climb a steep hill.

State the type of energy gained by cars as they climb the hill.

..... [1]

[Total: 7]

- 7 Fig. 7.1 shows an experiment to identify the pattern and direction of field lines around a bar magnet.

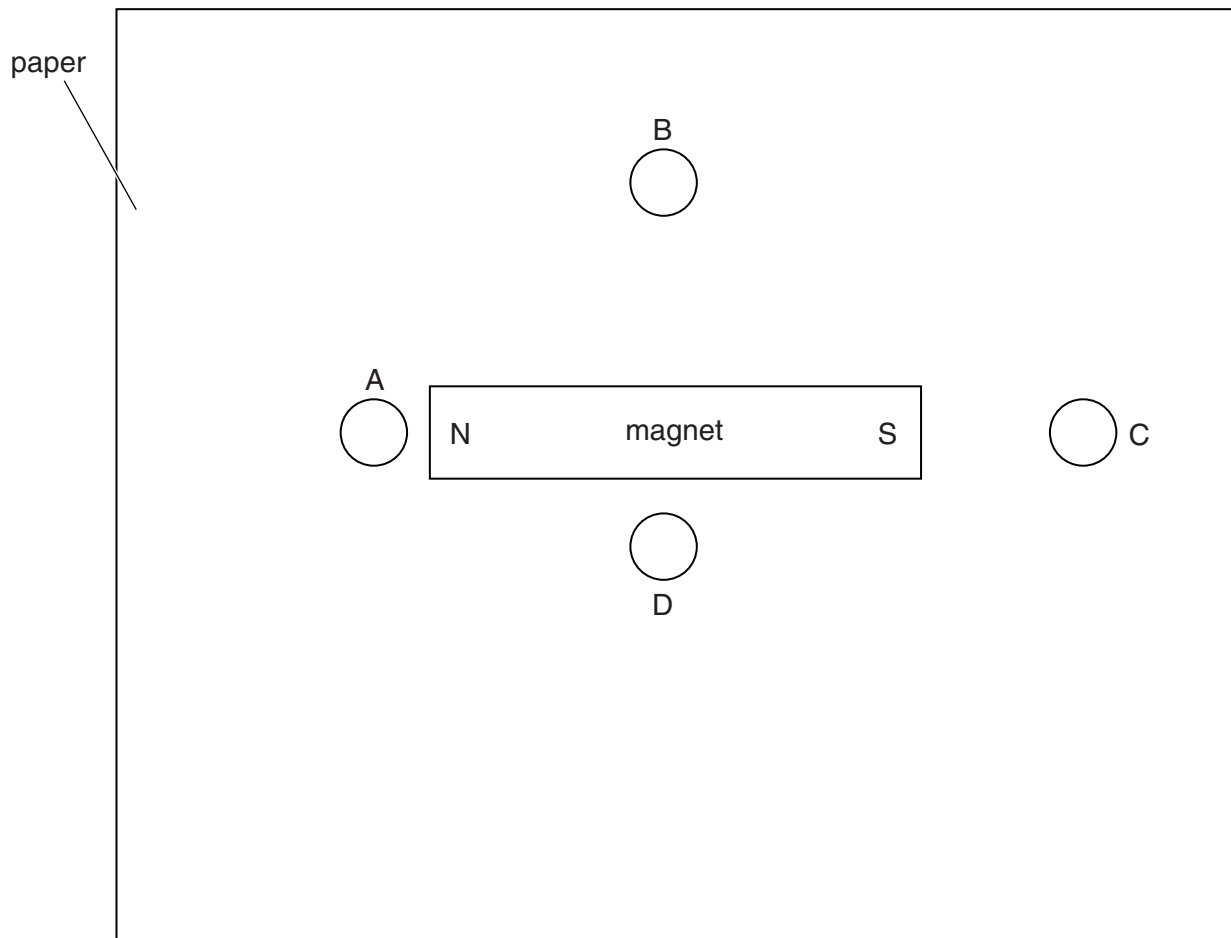

Fig. 7.1

The bar magnet is placed on a sheet of paper. A plotting compass is placed in each of the four positions labelled A, B, C and D.

The plotting compass is a small pivoted magnet, as shown in Fig. 7.2.

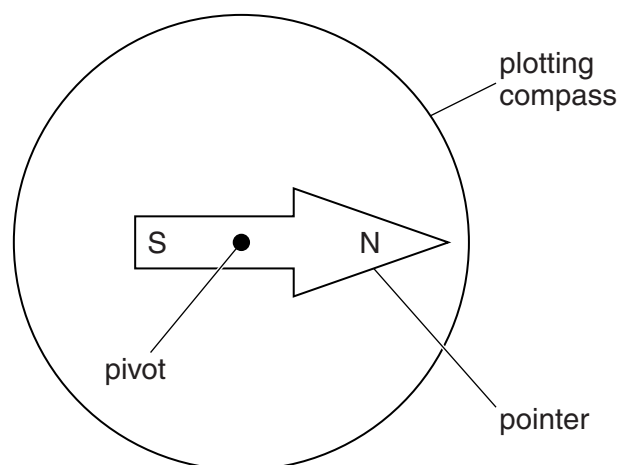

Fig. 7.2

- (a) In each of positions A, B, C and D on Fig. 7.1, carefully draw an arrow showing the position of the pointer. Ignore the magnetic field due to the surroundings. [3]
- (b) On Fig. 7.1, carefully draw two complete magnetic field lines, one through position B and the other through position D. The lines you draw should start and finish on the bar magnet. [1]
- (c) State the material from which a permanent magnet is made.

..... [1]

[Total: 5]

8 Fig. 8.1 shows part of a wiring diagram for a car.

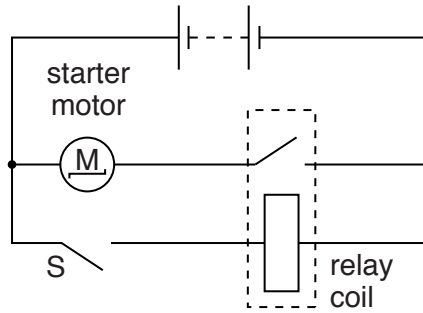

Fig. 8.1

When the driver closes switch S, there is a current of 200 A in the starter motor.

(a) (i) Explain how closing switch S causes the starter motor to operate.

.....

.....

..... [2]

(ii) Explain why the cable connecting the motor to the battery is much thicker than the wire connecting the switch S to the battery.

.....

.....

..... [2]

(b) Fig. 8.2 shows part of a lighting circuit for a car.

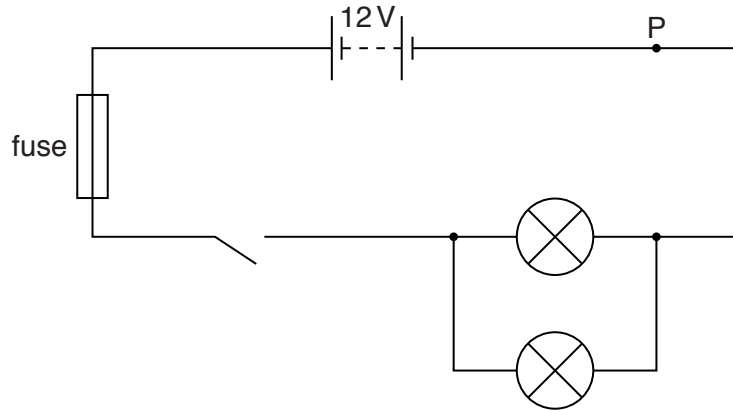

Fig. 8.2

(i) The switch is closed. There is a current of 1.2 A in the fuse.

State the current at point P.

current = A [1]

(ii) The lights of the car are connected in parallel.

State one reason for connecting lights in parallel.

..... [1]

[Total: 6]

- 9 A student investigates how the resistance of a thermistor changes with temperature. Fig. 9.1 shows the circuit that the student uses.

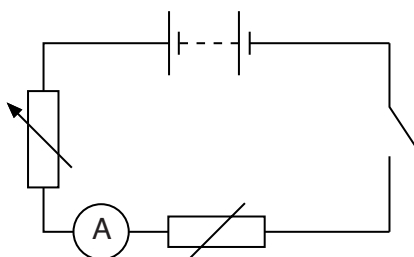

Fig. 9.1

- (a) (i) Label clearly the thermistor in Fig. 9.1. [1]
- (ii) On Fig. 9.1, draw a voltmeter connected so that the resistance of the thermistor can be determined. [2]
- (b) The student varies the temperature of the thermistor and records the ammeter readings. The results are shown in Table 9.1.

Table 9.1

| | | | | | | |
|---|-----|-----|-----|-----|------|------|
| temperature of thermistor/ $^{\circ}\text{C}$ | 0 | 10 | 20 | 30 | 40 | 50 |
| current in thermistor/ mA | 1.0 | 2.0 | 4.0 | 7.5 | 14.0 | 24.5 |

- (i) The potential difference (p.d.) across the thermistor is 6.0V at 20 $^{\circ}\text{C}$.

Calculate the resistance of the thermistor at 20 $^{\circ}\text{C}$. Include the unit.

resistance = [4]

(ii) Fig. 9.2 shows the student's results plotted on a graph.

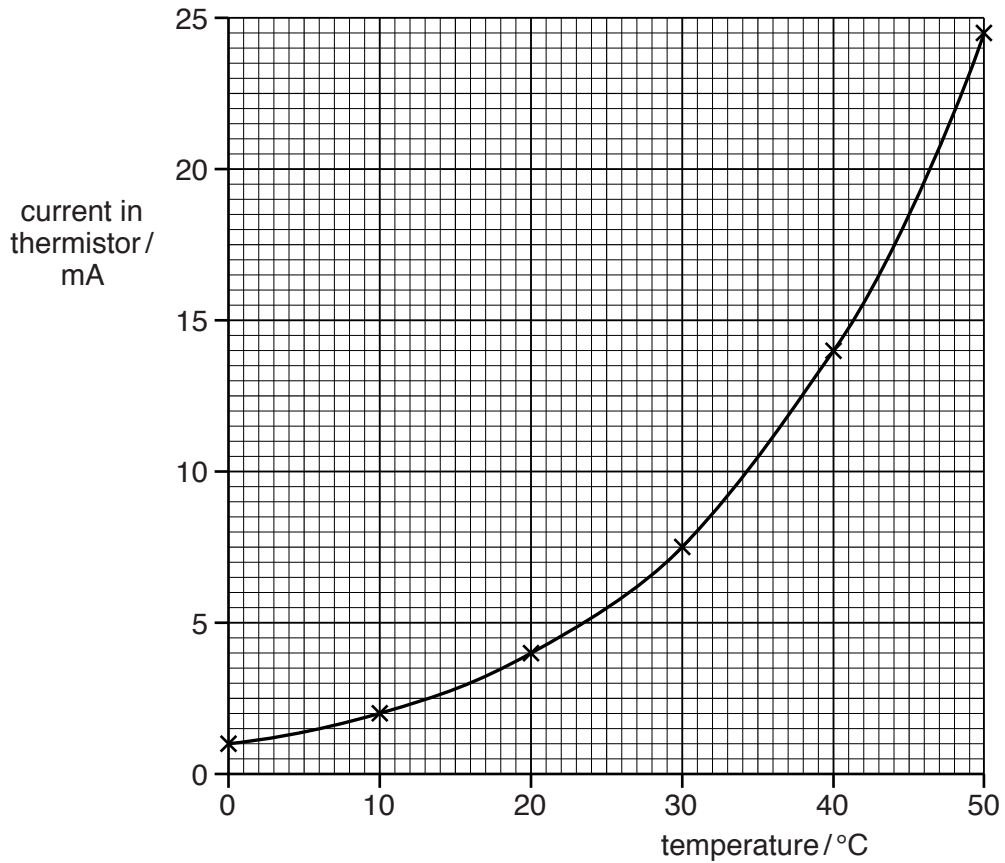

Fig. 9.2

The student suggests that the current in the thermistor is directly proportional to the temperature of the thermistor.

Explain how the graph shown in Fig. 9.2 shows that the suggestion is incorrect.

.....

..... [1]

[Total: 8]

- 10 A camera has a circuit containing a light-dependent resistor (LDR). Fig. 10.1 shows part of this circuit.

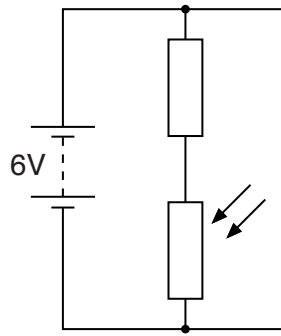

Fig. 10.1

- (a) Describe what happens to the resistance of the LDR and the current in the LDR when a bright light is shone on the LDR.

.....
 [2]

- (b) A camera lens is used to produce an image of an object OX. The arrangement is shown in Fig. 10.2.

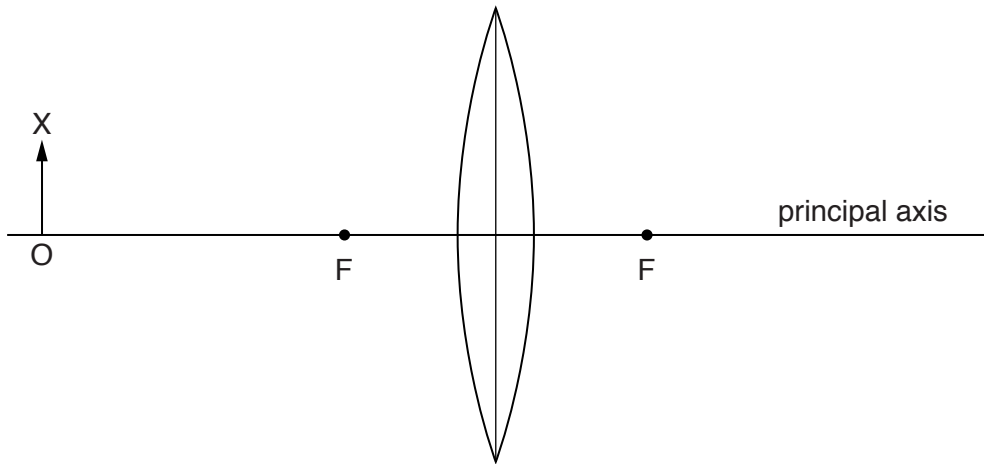

Fig. 10.2

The principal foci of the lens are labelled F.

On Fig. 10.2,

- (i) draw a ray from the top of the object, parallel to the principal axis and continuing through and beyond the lens, [2]
- (ii) draw in another ray to locate the position of the image of OX, [2]
- (iii) carefully draw and label the image obtained. [1]

[Total: 7]

11 Three types of radioactive decay are by the emission of

α - radiation,
 β - radiation,
 γ - radiation.

(a) State which of the three types of emission has the greatest speed.

..... [1]

(b) A nucleus of americium-241 decays to become a nucleus of neptunium-237 by the emission of one particle.

The equation below describes the change. The symbol A_ZX represents the particle emitted.

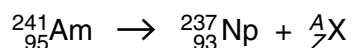

(i) State the name given to each of the numbers A and Z .

A is the number.

Z is the number.
 [2]

(ii) Determine the values of A and Z .

$A =$

$Z =$
 [2]

(iii) State the name of the particle emitted.

..... [1]

[Total: 6]

12 Fig. 12.1 is a diagram of a power station that uses coal.

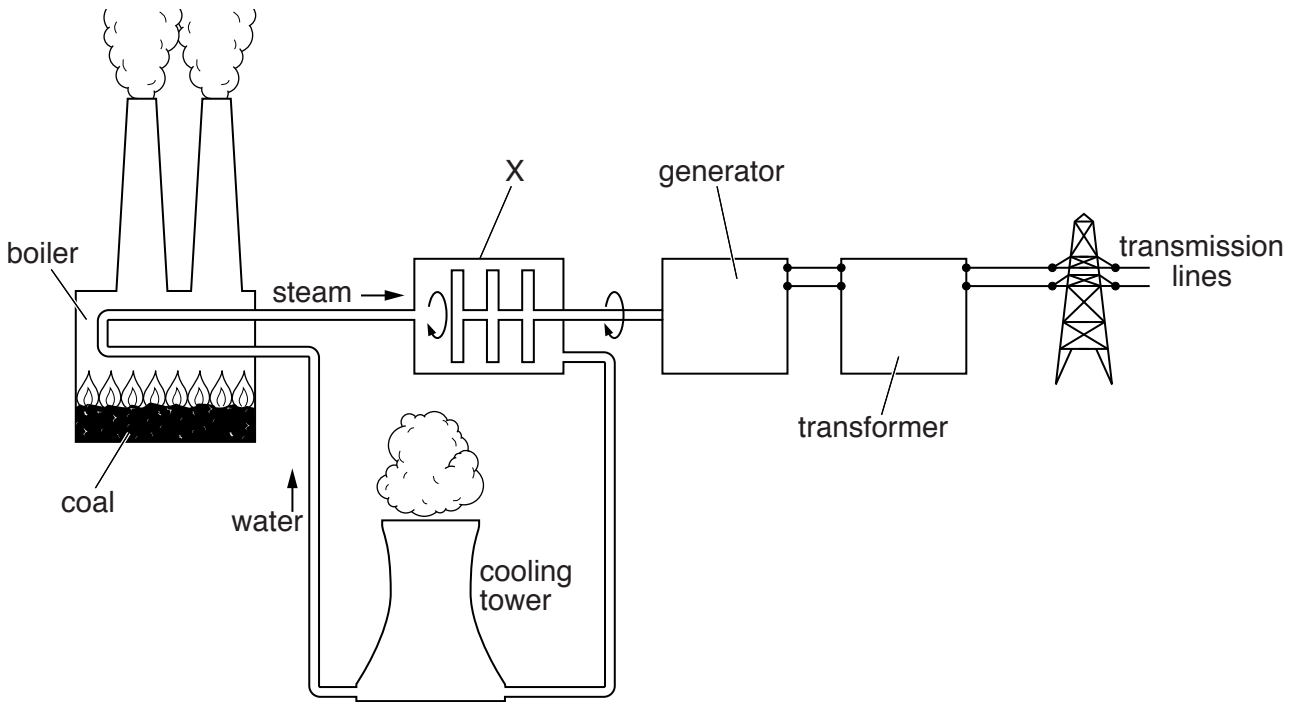

Fig. 12.1

(a) (i) State the name of the part of the power station labelled X.

..... [1]

(ii) State two disadvantages of generating electricity using fossil fuels.

1.

2.

[2]

(b) The transformer converts the 25kV output from the generator to 115kV. The primary coil of the transformer has 500 turns.

Calculate the number of turns on the secondary coil.

number of turns = [3]

(c) Explain the advantages of transmitting electricity at high voltages such as 115 kV.

.....

.....

..... [3]

[Total: 9]

BLANK PAGE

Permission to reproduce items where third-party owned material protected by copyright is included has been sought and cleared where possible. Every reasonable effort has been made by the publisher (UCLES) to trace copyright holders, but if any items requiring clearance have unwittingly been included, the publisher will be pleased to make amends at the earliest possible opportunity.

To avoid the issue of disclosure of answer-related information to candidates, all copyright acknowledgements are reproduced online in the Cambridge International Examinations Copyright Acknowledgements Booklet. This is produced for each series of examinations and is freely available to download at www.cie.org.uk after the live examination series.

Cambridge International Examinations is part of the Cambridge Assessment Group. Cambridge Assessment is the brand name of University of Cambridge Local Examinations Syndicate (UCLES), which is itself a department of the University of Cambridge.