

Candidate Name \_\_\_\_\_

Centre Number

Candidate  
Number

--	--

**International General Certificate of Secondary Education  
CAMBRIDGE INTERNATIONAL EXAMINATIONS**

**PHYSICS**

**0625/6**

PAPER 6 Alternative to Practical

**OCTOBER/NOVEMBER SESSION 2002**

1 hour

Candidates answer on the question paper.  
No additional materials required.

**TIME** 1 hour

**INSTRUCTIONS TO CANDIDATES**

Write your name, Centre number and candidate number in the spaces at the top of this page.

Answer **all** questions.

Write your answers in the spaces provided on the question paper.

**INFORMATION FOR CANDIDATES**

The number of marks is given in brackets [ ] at the end of each question or part question.

FOR EXAMINER'S USE	
1	
2	
3	
4	
5	
<b>TOTAL</b>	

---

**This question paper consists of 11 printed pages and 1 blank page.**



- 1 In an experiment to determine the volume of glass beads, a student used two different methods.

Method 1

The student measured the combined diameters of some beads and then calculated the volume of one bead. The end view of the apparatus used is shown in Fig. 1.1.

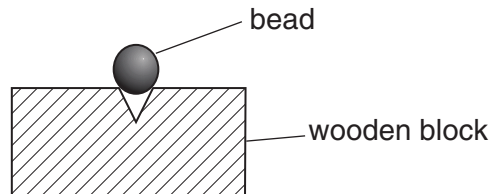

**Fig. 1.1**

Fig. 1.2 shows the side view of the same apparatus, drawn actual size.

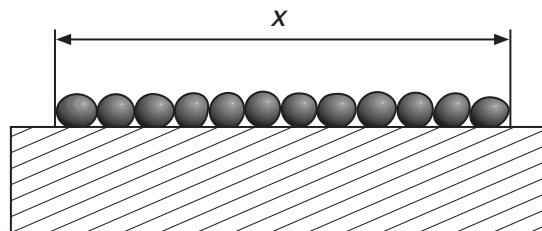

**Fig. 1.2**

- (a) (i) On Fig. 1.2, use your rule to measure the distance  $x$ , in cm.

.....

- (ii) Calculate  $d$ , the average diameter in cm of one glass bead. Show your working.

$d = \dots\dots\dots$  cm

- (iii) Calculate  $V$ , the volume of one glass bead using the equation

$$V = \frac{\pi d^3}{6}.$$

$V = \dots\dots\dots$ [6]

Method 2

The student used a displacement method to determine the volume of a glass bead. Fig. 1.3 and Fig. 1.4 show how this was done.

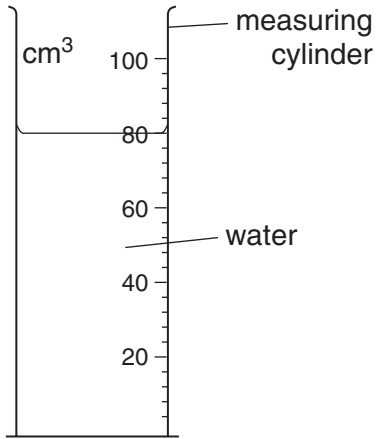

**Fig. 1.3**

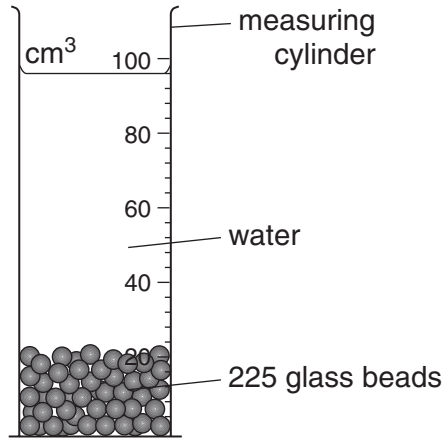

**Fig. 1.4**

(b) (i) Write down the values of the readings taken.

.....  
 .....

(ii) Calculate the volume of 225 glass beads.

volume = .....

(iii) Calculate  $V$ , the average volume of one glass bead.

$V = \dots\dots\dots$   
 [3]

(c) Suggest which of the two methods will give the more accurate result for the volume of a glass bead. Give a reason for your answer.

.....  
 .....

.....[1]

- 2 The IGCSE class is investigating electromagnets. The electromagnets are made by wrapping insulated wire around a soft-iron core. The wire is connected to a power pack. Fig. 2.1 shows the arrangement.

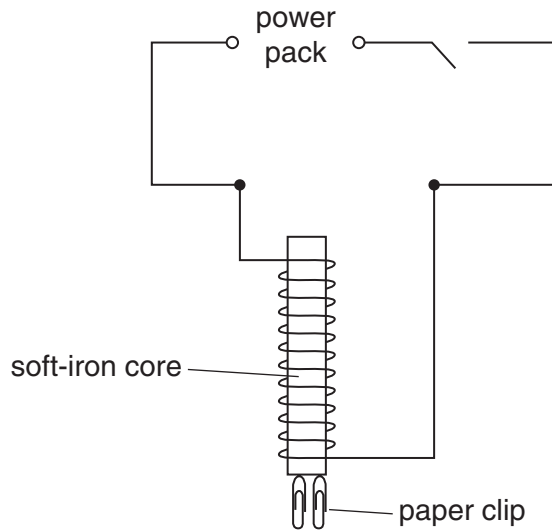

**Fig. 2.1**

Two students studied how the number of paper clips that an electromagnet can hold up depends on the potential difference across the coil.

- (a) Complete Fig. 2.1 by adding a voltmeter, connected to measure the p.d. across the coil. [2]
- (b) Student A used the control on the power pack to obtain set values of p.d. and recorded the **maximum** number of paper clips that the electromagnet could hold at each p.d. The results are shown below.

Student A

p.d./V	number of paper clips
0	0
2	0
4	1
6	2
8	3
10	4
12	5

Student B connected a variable resistor into the circuit and used it to change the p.d. across the coil. She recorded the **minimum** p.d. required to hold 1 paper clip, then 2 paper clips, etc. The results are shown below.

Student B

p.d./V	number of paper clips
0	0
2.2	1
4.5	2
6.6	3
8.7	4
11.0	5

- (i) Which set of results gives the more accurate indication of the strength of the electromagnet at different potential differences? Tick the correct box.

Student A

Student B

- (ii) Justify your answer to part (b)(i).

.....  
 .....  
 .....[2]

- (c) Draw the circuit symbol for a variable resistor.

[1]

- (d) On the diagram below, show the position of the pointer on the voltmeter when the voltmeter reading is 8.7 V.

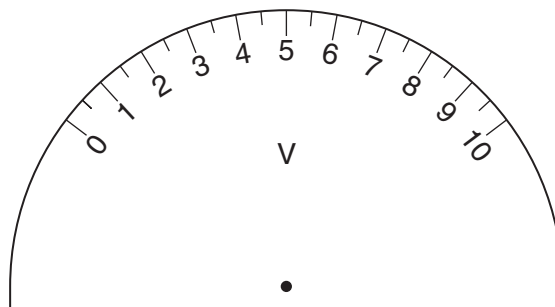

[1]

- 3 A student carried out a 'principle of moments' experiment using a metre rule placed on a pivot at the 50.0 cm mark. The aim was to determine an unknown weight. The arrangement of the apparatus is shown in Fig. 3.1.

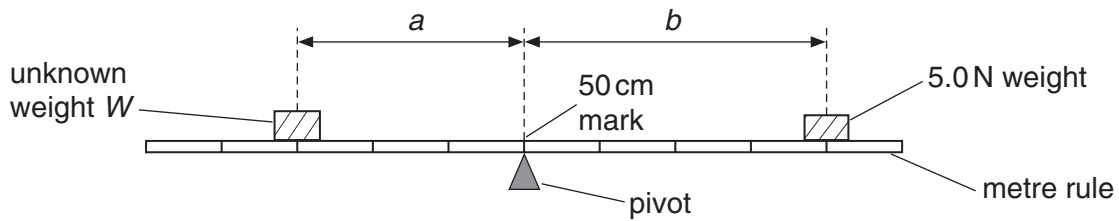
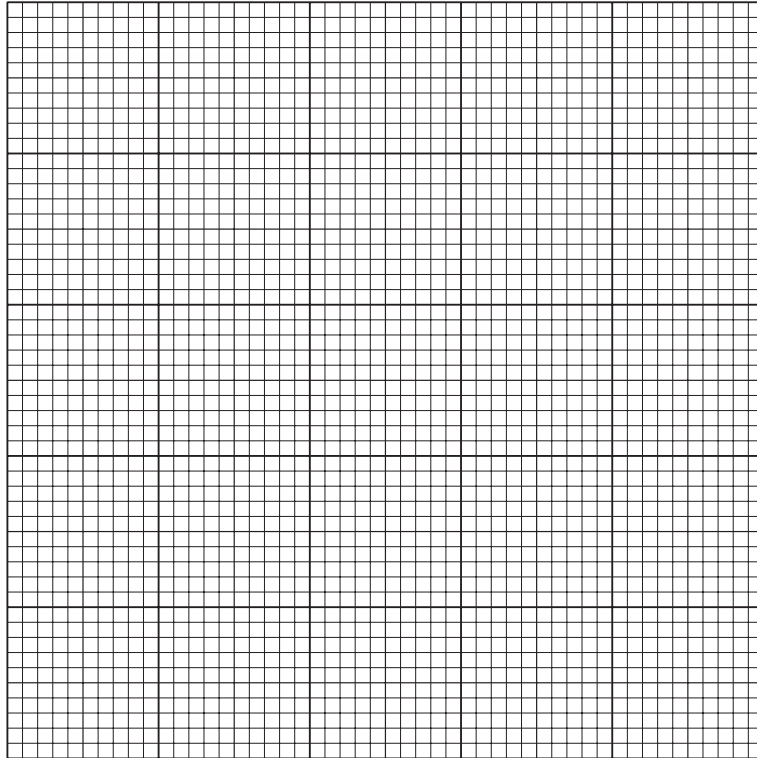

**Fig. 3.1**

The student placed the unknown weight  $W$  at a convenient distance  $a$  from the pivot. He found  $b$ , the distance from the pivot that the 5.0 N weight must be placed so that the rule balanced horizontally. He then repeated the experiment using different values of  $a$ . The readings are shown in the table below.

$a/m$	$b/m$
0.100	0.122
0.200	0.238
0.250	0.302
0.300	0.360
0.350	0.435
0.400	0.470

- (a) (i) Plot the graph of  $b/m$  ( $y$ -axis) against  $a/m$  ( $x$ -axis).  
 (ii) Draw the best-fit straight line.



[6]

- (iii) Determine  $G$ , the gradient of the line.

$$G = \dots\dots\dots$$

- (iv) Determine  $W$ , the unknown weight, using the equation

$$W = XG$$

where  $X = 5.0 \text{ N}$ .

$$W = \dots\dots\dots$$

- (v) Explain why the student could not choose distance  $a$  to have a value of 0.450 m.

.....  
 .....[5]

- (b) Another student, who was performing this experiment, found that the unloaded metre rule balanced on the pivot at the 50.3 cm mark, instead of the 50.0 cm mark. Suggest what the student should do to obtain the correct value for  $W$  from the experiment.

.....  
 .....[1]

- 4 The IGCSE class was performing a heating experiment. The apparatus is shown in Fig. 4.1. The aim was to determine the rate at which the temperature of  $200 \text{ cm}^3$  of water increased when heated with an electric immersion heater.

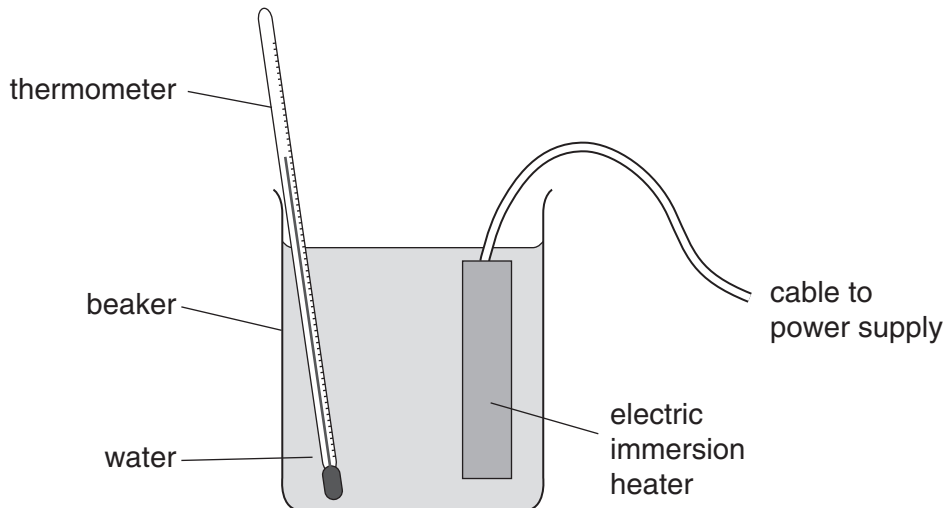

**Fig. 4.1**



The water was heated from room temperature up to 60 °C. The teacher measured the power of the immersion heater and calculated (correctly) the time required to raise the temperature of 200 cm<sup>3</sup> of water from 21 °C to 60 °C.

The students found that the water must be heated for longer than the calculated time.

(a) (i) What is the most likely cause of the longer time recorded?

Tick the appropriate box.

- an inaccurate thermometer
- errors in reading the stopwatch
- heat loss during the experiment

(ii) Suggest **two** precautions that could be taken to obtain more accurate results.

.....

.....

.....

.....[3]

(b) What is the reading on the thermometer shown in Fig. 4.2?

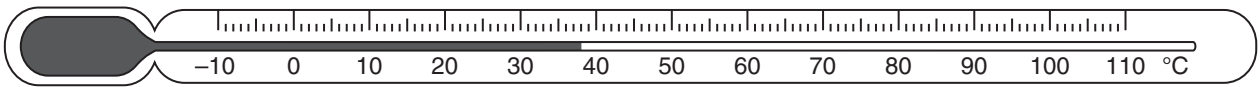

Fig. 4.2

reading = ..... [1]

(c) The power  $P$  of the immersion heater is calculated using the equation  $P = VI$

Calculate the power of an immersion heater in which the current is 5.5 A when the p.d. across it is 12.0 V.

.....

.....[2]

- 5 A student carried out a lens experiment to investigate the magnification of an image. The apparatus is shown in Fig. 5.1.

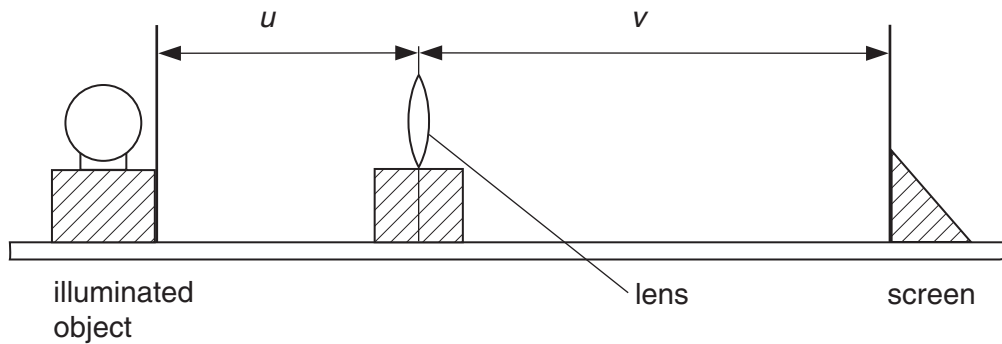

**Fig. 5.1**

The object is a triangular hole in a screen. Fig. 5.2 shows this, actual size.

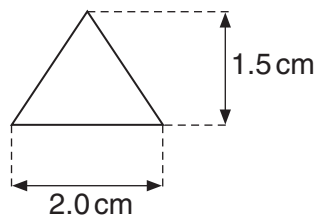

**Fig. 5.2**

The student set the distance  $u$  at 35.0 cm and moved the screen to obtain a sharply focused image. The image distance  $v$  was 72.3 cm.

- (a) (i) Calculate  $m$ , the magnification, using the equation

$$m = v/u.$$

$$m = \dots\dots\dots$$

(ii) Draw a diagram of the image, actual size, for a magnification  $m = 2.0$ .

[5]

(b) The image distance  $v$  is the distance from the screen to the **centre** of the lens.  
Explain briefly how you would position a metre rule to obtain an accurate value for  $v$ .  
You may draw a diagram.

.....

.....

.....[1]

