



1

For  
Examiner's  
Use

Mathematics mark	30	50	35	25	5	39	48	40	10	15
English mark	26	39	35	28	9	37	45	33	16	12

The table shows the test marks in Mathematics and English for 10 students.

- (a) (i) On the grid, complete the scatter diagram to show the Mathematics and English marks for the 10 students. The first four points have been plotted for you.

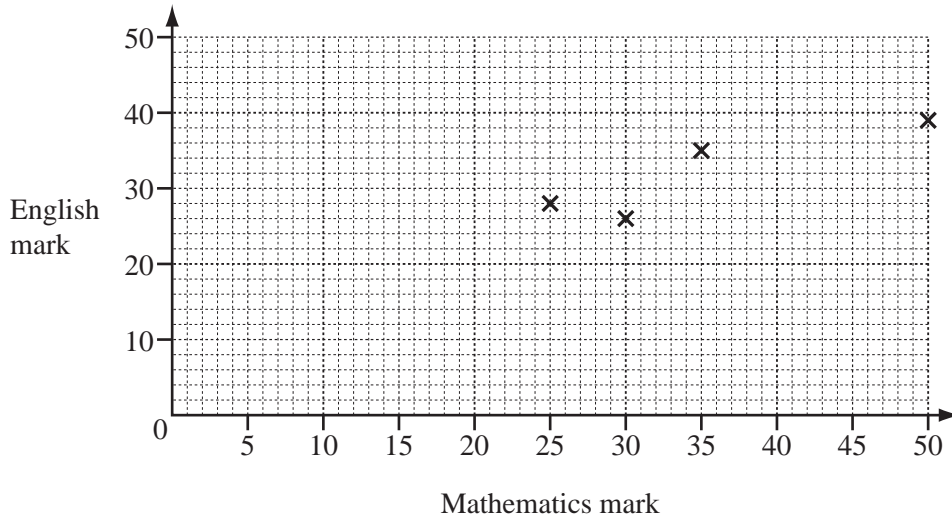

- (ii) What type of correlation does your scatter diagram show? [2]

Answer(a)(ii) ..... [1]

- (iii) Draw a line of best fit on the grid. [1]

- (iv) Ann missed the English test but scored 22 marks in the Mathematics test. Use your line of best fit to estimate a possible English mark for Ann.

Answer(a)(iv) ..... [1]

- (b) Show that the mean English mark for the 10 students is 28.

Answer(b)

[2]

- (c) Two new students do the English test. They both score the **same** mark. The mean English mark for the 12 students is 31. Calculate the English mark for the new students.

Answer(c) ..... [3]

- 2 (a) In a sale, Jen buys a laptop for \$351.55.  
This price is 21% less than the price before the sale.
- Calculate the price before the sale.

For  
Examiner's  
Use

*Answer(a)* \$ ..... [3]

- (b) Alex invests \$4000 at a rate of 8% per year simple interest for 2 years.  
Bob invests \$4000 at a rate of 7.5% per year compound interest for 2 years.

Who receives more interest and by how much?

*Answer(b)* ..... receives \$ ..... more interest. [6]

3 Pablo plants  $x$  lemon trees and  $y$  orange trees.

(a) (i) He plants at least 4 lemon trees.

Write down an inequality in  $x$  to show this information.

Answer(a)(i) ..... [1]

(ii) Pablo plants at least 9 orange trees.

Write down an inequality in  $y$  to show this information.

Answer(a)(ii) ..... [1]

(iii) The greatest possible number of trees he can plant is 20.

Write down an inequality in  $x$  and  $y$  to show this information.

Answer(a)(iii) ..... [1]

(b) Lemon trees cost \$5 each and orange trees cost \$10 each.

The maximum Pablo can spend is \$170.

Write down an inequality in  $x$  and  $y$  and show that it simplifies to  $x + 2y \leq 34$ .

Answer (b)

[1]

(c) (i) On the grid opposite, draw four lines to show the four inequalities and shade the **unwanted** region.

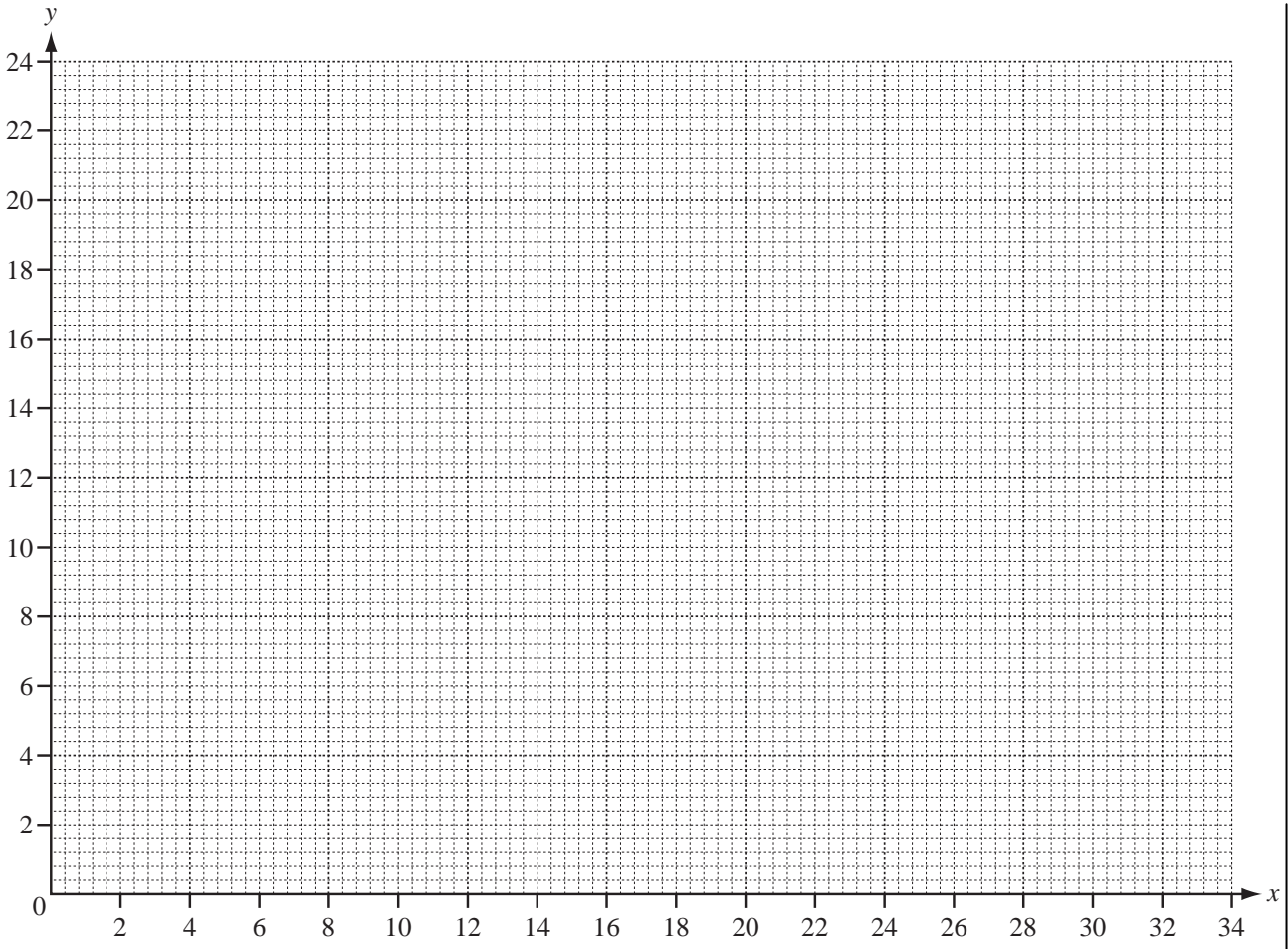

[7]

(ii) Calculate the smallest cost when Pablo buys a total of 20 trees.

Answer(c)(ii) \$ ..... [2]

4 (a)

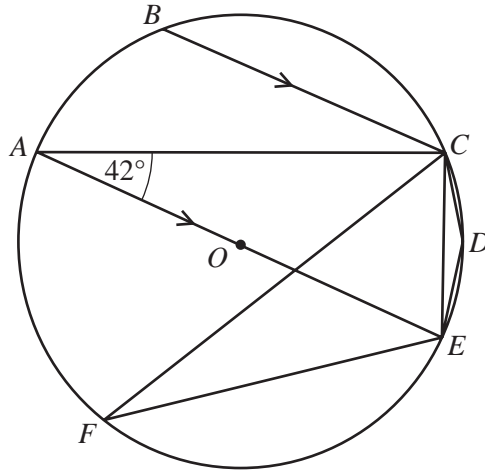
NOT TO  
SCALE

$A, B, C, D, E$  and  $F$  are points on the circumference of a circle centre  $O$ .  
 $AE$  is a diameter of the circle.  
 $BC$  is parallel to  $AE$  and angle  $CAE = 42^\circ$ .

Giving a reason for each answer, find

(i) angle  $BCA$ ,

Answer(a)(i) Angle  $BCA =$  .....

Reason ..... [2]

(ii) angle  $ACE$ ,

Answer(a)(ii) Angle  $ACE =$  .....

Reason ..... [2]

(iii) angle  $CFE$ ,

Answer(a)(iii) Angle  $CFE =$  .....

Reason ..... [2]

(iv) angle  $CDE$ .

Answer(a)(iv) Angle  $CDE =$  .....

Reason ..... [2]

(b)

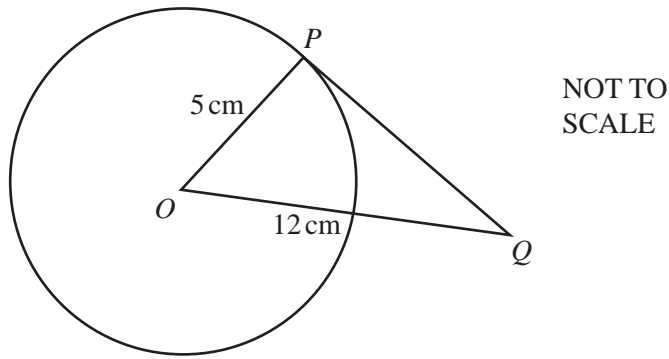

In the diagram,  $O$  is the centre of the circle and  $PQ$  is a tangent to the circle at  $P$ .  
 $OP = 5$  cm and  $OQ = 12$  cm.

Calculate  $PQ$ .

Answer(b)  $PQ = \dots\dots\dots$  cm [3]

(c)

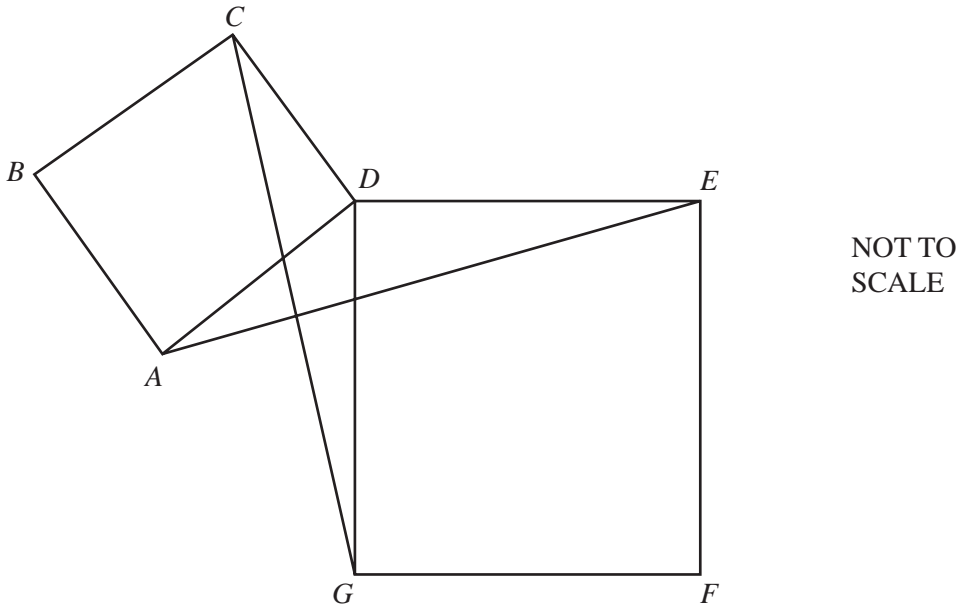

In the diagram,  $ABCD$  and  $DEFG$  are squares.

(i) In the triangles  $CDG$  and  $ADE$ , explain with a reason which sides and/or angles are equal.

Answer (c)(i)

[3]

(ii) Complete the following statement.

Triangle  $CDG$  is ..... to triangle  $ADE$ .

[1]

- 5 (a) In Portugal, Miguel buys a book about planets.  
The book costs €34.95.  
In England the same book costs £27.50.  
The exchange rate is £1 = €1.17.

Calculate the difference in pounds (£) between the cost of the book in Portugal and England.

Answer(a) £ ..... [2]

- (b) In the book, the distance between two planets is given as  $4.07 \times 10^{12}$  kilometres.  
The speed of light is  $1.1 \times 10^9$  kilometres per hour.

Calculate the time taken for light to travel from one of these planets to the other.  
Give your answer in days and hours.

Answer(b) ..... days ..... hours [3]

- (c) In one of the pictures in the book, a rectangle is drawn.  
The rectangle has length 9.3 cm and width 5.6 cm, both correct to one decimal place.

- (i) What is the lower bound for the length?

Answer(c)(i) ..... cm [1]

- (ii) Work out the lower and upper bounds for the area of the rectangle.

Answer(c)(ii) Lower bound = .....  $\text{cm}^2$

Upper bound = .....  $\text{cm}^2$  [2]



6 (a)

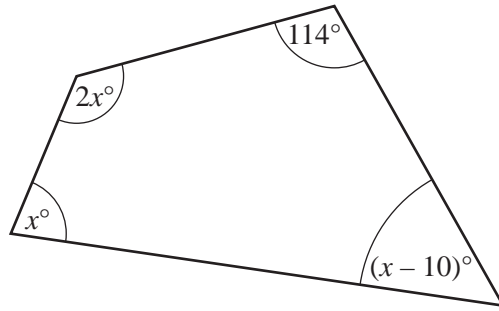

NOT TO SCALE

Find the value of  $x$ .

Answer(a)  $x = \dots\dots\dots$  [3]

(b) (i) Write the four missing terms in the table for sequences A, B, C and D.

Term	1	2	3	4	5		$n$
Sequence A	-4		2	5	8		$3n - 7$
Sequence B	1	4	9	16	25		
Sequence C	5	10	15	20	25		
Sequence D	6	14	24	36	50		

[4]

(ii) Which term in sequence D is equal to 500?

Answer(b)(ii)  $\dots\dots\dots$  [2]

(c) Simplify  $\frac{x^2 - 16}{2x^2 + 7x - 4}$ .

Answer(c)  $\dots\dots\dots$  [4]

For Examiner's Use

7 (a)  $P$  is the point  $(2, 5)$  and  $\vec{PQ} = \begin{pmatrix} 3 \\ -2 \end{pmatrix}$ .

Write down the co-ordinates of  $Q$ .

Answer(a) ( ..... , ..... ) [1]

(b)

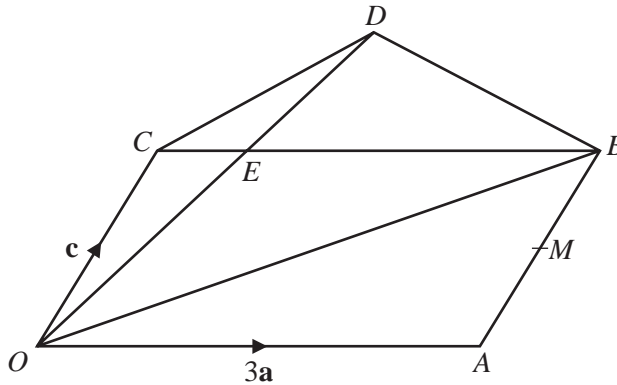

NOT TO  
SCALE

$O$  is the origin and  $OACB$  is a parallelogram.  
 $M$  is the midpoint of  $AB$ .

$\vec{OC} = \mathbf{c}$ ,  $\vec{OA} = 3\mathbf{a}$  and  $CE = \frac{1}{3}CB$ .

$OED$  is a straight line with  $OE : ED = 2 : 1$ .

Find in terms of  $\mathbf{a}$  and  $\mathbf{c}$ , in their simplest forms

(i)  $\vec{OB}$ ,

Answer(b)(i)  $\vec{OB} = \dots\dots\dots$  [1]

(ii) the position vector of  $M$ ,

Answer(b)(ii)  $\dots\dots\dots$  [2]

(iii)  $\vec{OE}$ ,

Answer(b)(iii)  $\vec{OE} = \dots\dots\dots$  [1]

(iv)  $\vec{CD}$ .

Answer(b)(iv)  $\vec{CD} = \dots\dots\dots$  [2]

(c) Write down two facts about the lines  $CD$  and  $OB$ .

Answer (c)  $\dots\dots\dots$   
 $\dots\dots\dots$  [2]

8 In all parts of this question give your answer as a fraction in its lowest terms.

For  
Examiner's  
Use

(a) (i) The probability that it will rain today is  $\frac{1}{3}$ .

What is the probability that it will not rain today?

Answer(a)(i) ..... [1]

(ii) If it rains today, the probability that it will rain tomorrow is  $\frac{2}{5}$ .

If it does not rain today, the probability that it will rain tomorrow is  $\frac{1}{6}$ .

Complete the tree diagram.

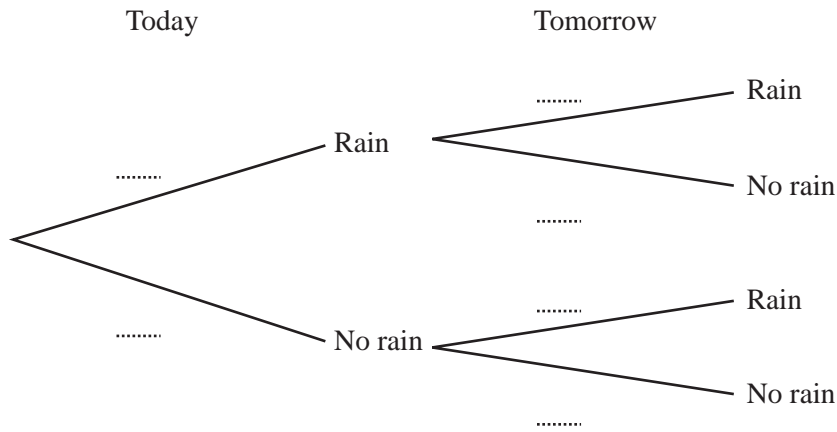

[2]

(b) Find the probability that it will rain on at least one of these two days.

Answer(b) ..... [3]

(c) Find the probability that it will rain on only one of these two days.

Answer(c) ..... [3]

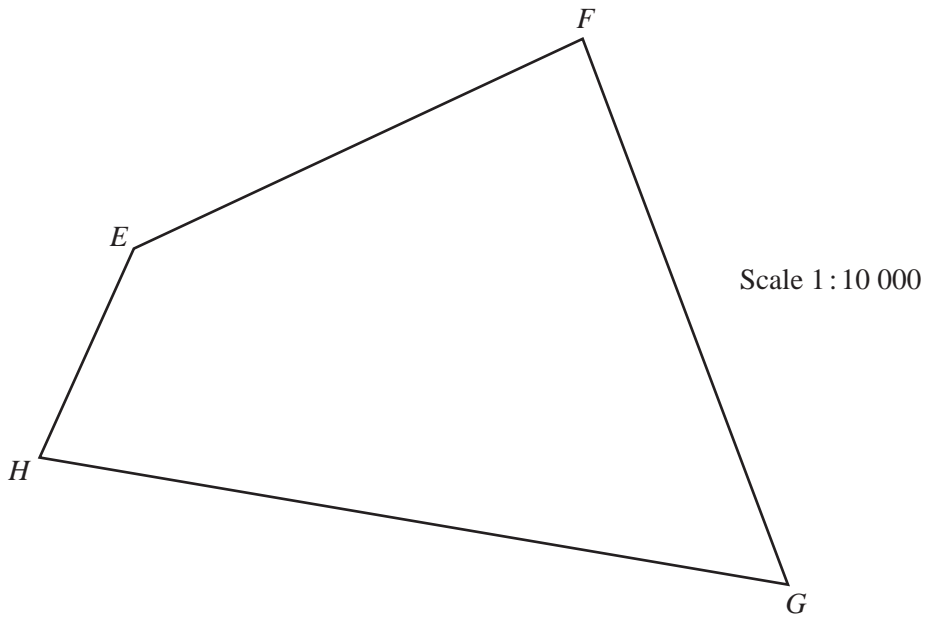

The diagram is a scale drawing of a park  $EFGH$ . The scale is 1:10 000.

A statue is to be placed in the park so that it is

- nearer to  $G$  than to  $H$
- nearer to  $HG$  than to  $FG$
- more than 550 metres from  $F$ .

Construct accurately the boundaries of the region  $R$  in which the statue can be placed.

Leave in all your construction arcs and shade the region  $R$ .

[7]

10 (a) Simplify

(i)  $(2x^2y^3)^3$ ,

Answer(a)(i) ..... [2]

(ii)  $\left(\frac{27}{x^6}\right)^{-\frac{1}{3}}$ .

Answer(a)(ii) ..... [3]

(b) Multiply out and simplify.

$$(3x - 2y)(2x + 5y)$$

Answer(b) ..... [3]

(c) Make  $h$  the subject of

(i)  $V = \pi r^3 + 2\pi r^2 h$ ,

Answer(c)(i)  $h =$  ..... [2]

(ii)  $V = \sqrt{3h}$ .

Answer(c)(ii)  $h =$  ..... [2]

(d) Write as a single fraction in its simplest form.

$$\frac{x}{2} + \frac{5x}{3} - \frac{7x}{4}$$

Answer(d) ..... [2]

11 (a) Calculate the area of a circle with radius 12 cm.

For  
Examiner's  
Use

Answer(a) ..... cm<sup>2</sup> [2]

(b)

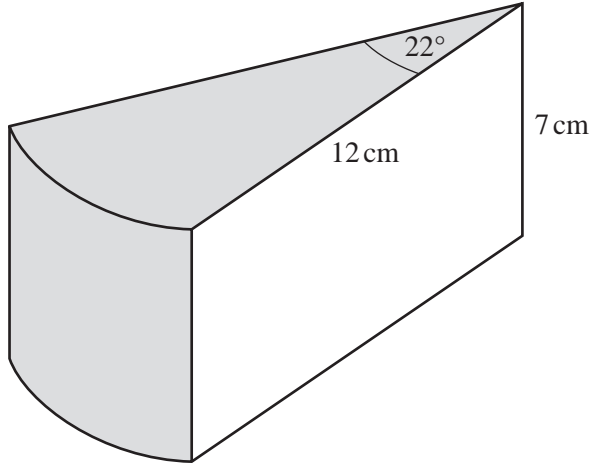

NOT TO  
SCALE

A circular cake has radius 12 cm and height 7 cm.  
The uniform cross-section of a slice of the cake is a sector with angle 22°.  
The top and the curved surface of the slice, shaded in the diagram, are covered with chocolate.

Calculate the area of the slice which is covered with chocolate.

Answer(b) ..... cm<sup>2</sup> [5]

(c)

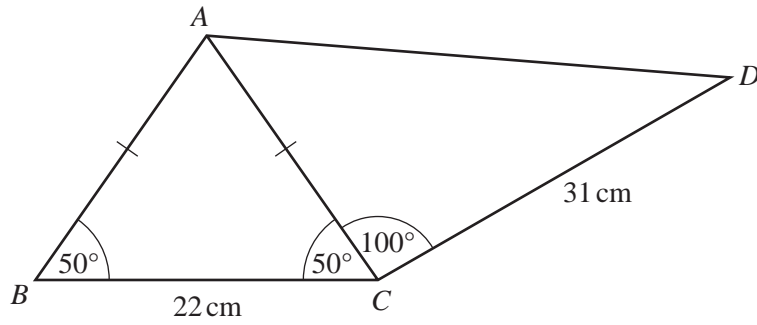
NOT TO  
SCALE

The frame of a child's bicycle is made from metal rods.  
 $ABC$  is an isosceles triangle with base 22 cm and base angles  $50^\circ$ .  
 Angle  $ACD = 100^\circ$  and  $CD = 31$  cm.

Calculate the length  $AD$ .

Answer(c)  $AD =$  ..... cm [6]

Question 12 is printed on the next page.

For  
Examiner's  
Use

- 12 (a) The cost of 1 kg of tomatoes is \$ $x$  and the cost of 1 kg of onions is \$ $y$ .

Ian pays a total of \$10.70 for 10 kg of tomatoes and 4 kg of onions.

Jao pays a total of \$10.10 for 8 kg of tomatoes and 6 kg of onions.

Write down simultaneous equations and solve them to find  $x$  and  $y$ .

For  
Examiner's  
Use

Answer(a)  $x =$  .....

$y =$  ..... [6]

- (b) Solve  $2x^2 - 5x - 8 = 0$ .

Give your answers correct to 2 decimal places.  
Show all your working.

Answer(b)  $x =$  ..... or  $x =$  ..... [4]

Permission to reproduce items where third-party owned material protected by copyright is included has been sought and cleared where possible. Every reasonable effort has been made by the publisher (UCLES) to trace copyright holders, but if any items requiring clearance have unwittingly been included, the publisher will be pleased to make amends at the earliest possible opportunity.

University of Cambridge International Examinations is part of the Cambridge Assessment Group. Cambridge Assessment is the brand name of University of Cambridge Local Examinations Syndicate (UCLES), which is itself a department of the University of Cambridge.